



VIVAX
METROTECH

VM-810/VM-850
Pipe and Cable Locator
User Handbook
(English Edition)

Version 2.2

P/N: 4.04.000027



General Safety & Care Information

Who Can Use This Equipment

- This equipment must only be used by people suitably trained in the use of pipe and cable locators.

Work-site Safety

- Use your company's, or other applicable safety codes and rules when using this equipment.
- Unless having the required authorization, license, and appropriate training – do not make connections to any pipe, cable, or conductor.
- The equipment should not come in contact with corrosive or hazardous chemicals or gases or dust.
- **Do not** directly connect this equipment to cables or pipes that have a potential difference to ground of greater than 25V AC.
- Equipment Safety
- **Do not** open the enclosures (housings) of either the transmitter or receiver.
- Place the ground stake firmly in the ground before connecting the cable from the transmitter.
- **Do not** hold any uninsulated portion of the connection leads & clips when the transmitter is switched on.

Batteries and Environmental Safety

Vivax-Metrotech products use four types of batteries:

- Alkaline batteries
- Ni-MH (Nickel-Metal Hydride) batteries – rechargeable
- Lithium-Ion batteries – rechargeable
- Lithium-Metal batteries – (small non-rechargeable button cells for “clock” applications)

1. Alkaline Batteries (Non-Rechargeable)

- When replacing the alkaline batteries – use only the size and type specified – do not mix battery types (rechargeable and alkaline).
- **Do not** mix partially discharged and fully charged cells in the same battery pack – do not mix old with new.
- **Never** attempt to charge alkaline batteries.

2. Nickel-Metal Hydride Batteries (Rechargeable)

- When using rechargeable batteries, use only the correct charging device supplied or specified by the manufacturer. The battery pack or battery charger will contain circuitry to manage the charging process. Other chargers (even if they have the same connector, polarity, voltage & current rating) will not have the same control circuitry. They may cause damage to the product, overheating, and in extreme cases, fire or harm to the individual.
- **Do not** assume that if the plug fits, it is the correct charger – a charger with the correct part number **must** be used – just because it is a Vivax-Metrotech charger, and the plug fits **do not** mean it is the correct charger.
- Before using for the first time, charge rechargeable batteries for six hours. If at any time, the rechargeable batteries **do not** last as long as anticipated – discharge fully and then charge for six hours.
- Care should be taken when charging batteries – **Never** repeatedly recharge batteries (or turn the power off & on) without using the instrument. If used with an inverter in a vehicle – charge the product, then unplug the charger, and **do not** charge again until the rechargeable batteries have been used for at least ten minutes. Failure to do so may result in overcharging the battery. This will shorten the life of the battery and, in some circumstances, result in overheating or fire.
- If ever the product becomes hot during the charging process, **immediately** unplug the charger and use the rechargeable batteries for at least ten minutes before recharging. If this reoccurs the next time the unit is charged – return immediately to Vivax-Metrotech for repair.
- **Do not** charge batteries for prolonged periods without using the locator for at least ten minutes. Charging for a prolonged period could overcharge the battery, reduce battery life, and in extreme circumstances, cause damage to the locator and fire.

3. Lithium-Ion Batteries (Rechargeable)

- Lithium-Ion Batteries – some products use Lithium-Ion batteries – the requirements for marking and transportation are still developing. Please contact Vivax-Metrotech before shipping products containing Lithium-Ion batteries or Lithium-Ion battery packs on their own for any “special instructions.”

4. Lithium-Metal Batteries (Non-Rechargeable)

- Commonly known as “button cells,” these are small – non-rechargeable batteries used to power internal “clocks” within some units (similar to computers). Generally, they have a life of three to five years.
- Under no circumstances should any attempt be made to charge these batteries.
- Dispose of following your company's work practice/environmental standards, the prevailing laws, or recognized best practice. Always dispose of batteries responsibly.

5. Rules regarding Disposal of Batteries

- **Never** disassemble a battery or battery pack.
- **Never** dispose of in a fire or water.
- Dispose of batteries following your company's work practice/environmental standards, the prevailing laws, or recognized best practice. Always dispose of batteries responsibly.

6. Transportation of Lithium-Ion and Lithium-Metal Batteries

- The Lithium-Ion and Lithium-Metal batteries used in Vivax-Metrotech products meet the required safety standards and include the designated protection circuitry.
- Recent regulation changes require that when batteries with Lithium-Ion and Lithium-Metal batteries are transported, the packaging **must** include specified warning labels. **Please contact Vivax-Metrotech Customer Service (USA 1-800-446-3392, International +1-408-734-1400 (USA Pacific Time Zone)) for more details.**
- Regulations have also changed regarding the shipping of spare battery packs (battery packs that are not inside a product). There are limitations on the weight of the package, and the packaging **must** be marked with the appropriate warning labels. **Please contact Vivax-Metrotech Customer Service (USA 1-800-446-3392, International +1-408-734-1400 (USA Pacific Time Zone)) for more details.**
- Vivax-Metrotech VM Series products using Lithium-Ion batteries are classified as "not restricted" and can be shipped by road/rail/sea & air (passenger & freight aircraft) without restrictions.



IMPORTANT

Remember – Batteries contain dangerous chemicals – They can be affected by many things such as water ingress or heat – In some circumstances, they can explode. They also can cause electric shocks!

Care of Equipment

- Use equipment only as directed in this User Handbook.
- **Do not** immerse any part of this equipment in water.
- Store in a dry place.
- Keep equipment in the case provided when not in use.
- If left for a prolonged period – remove the alkaline batteries.
- Keep the unit clean and free of dust and dirt.
- Protect against excessive heat.

Care when Interpreting the Information provided by the Locator

- Like all locators – this instrument is locating and providing depth and current readings based on electromagnetic signals that radiate from the buried cable or pipe. In most cases, these signals will enable the locator to pinpoint both position depth and current correctly.
- **Beware** – in some cases, other factors will distort electromagnetic fields radiating from cable or pipe being located, resulting in incorrect information.
- Always locate responsibly and use information learned during your training to interpret the information provided by the locator.
- **Do not** provide information regarding depth readings to anyone unless authorized to do so by your company.
- **Remember** that depth measurements are to the center of the electromagnetic field or pipe – In the case of pipes, this may be significantly deeper than the top of the pipe.

American & Canadian Safety Notices

USA

- This transmitter and receiver comply with the general conditions of operation, according to part 15 of the FCC Rules.
 - o CFR 47 Part 15
- Changes or modifications not expressly approved by the manufacturer could void the user's authority to operate the products.

CANADA

- Equipment is for use by trained operators only, and not for general household or consumer use.
- Operation is subject to the following two conditions: (1) this device may not cause interference, and (2) this device must accept any interference that may cause undesired operation of the device.

EUROPE

- Vivax-Metrotech confirms that the location system is compliant with the relevant provision of European directive 1999/5/EC.
 - o EN 55011
 - o EN 61000-4-2: A1 & A2
 - o EN 61000-4-3
 - o EN 61000-4-8: A1

EMC Compliance

(for VM-810 Tx and VM-850 Tx only)

Changes or modifications not expressly approved by the party responsible for compliance could void the user's authority to operate the equipment.

This equipment has been tested and found to comply with the limits for a Class B digital device, according to part 15 of the FCC Rules. These limits are designed to provide reasonable protection against harmful interference in a residential installation. This equipment generates uses and can radiate radio frequency energy and, if not installed and used following the instructions, may cause harmful interference to radio communications. However, there is no guarantee that interference will not occur in a particular installation. If this equipment does cause harmful interference to radio or television reception, which can be determined by turning the equipment off and on, the user is encouraged to try to correct the interference by one or more of the following measures:

- Reorient or relocate the receiving antenna.
- Increase the separation between the equipment and receiver.
- Connect the equipment into an outlet on a circuit different from that to which the receiver is connected.

Table of Content

1.	Service & Support.....	1
1.1	Serial Number and Software Revision Number	1
1.2	Worldwide Sales Offices and Service Centers.....	2
2.	Introduction.....	3
2.1	VM-810/VM-850.....	3
2.2	VM-810/VM-850 Receiver Controls and Indicators.....	5
2.3	VM-810/VM-850 Transmitter Controls and Indicators.....	6
3.	Check-Out Procedure.....	8
3.1	Introduction	8
4.	Operation.....	11
4.1	Transmitter – Direct Connection.....	11
4.2	Transmitter – Inductive Coupling.....	12
4.3	Transmitter – Inductive Method.....	13
4.4	Using the Receiver.....	14
4.5	Determining the Depth and Signal Current applied to a Conductor.....	15
4.6	Sonde Mode.....	17
4.6.1	Checkout Procedure for Locating Sondes.....	17
4.6.2	Operation in Sonde Mode.....	17
4.6.3	Sonde Location.....	19
4.6.4	Using the Sonde Direction Feature to Locate Sondes.....	19
5.	Ground Survey Procedure.....	21
5.1	Applications.....	21
5.2	Locating Conductors.....	21
5.3	Subdividing Large Search Areas.....	21
6.	Tracing Techniques and Helpful Information	22
6.1	Soil Conditions.....	22
6.2	Adjacent Conductors.....	22
6.3	Signal Clamp: Ground Requirements	22
6.4	Grounding: Safety.....	22
6.5	Distribution Systems.....	22
6.6	Deep Conductor.....	22
6.7	What is Field Strength of the Signal?.....	23
6.8	“Ghost” Conductor Due to Adjacent Conductor.....	23
6.9	Completing the Circuit Path	23
6.10	Common Bonded Conductors.....	24
6.11	Congested Areas.....	24
6.12	Locating a Service Lateral.....	25
6.13	Valves, Manhole Covers, Tees and Risers.....	25
7.	Maintenance.....	26
7.1	VM-810/VM-850 Receiver Calibration.....	26
7.2	Replacing the VM-810/VM-850 Receiver Batteries.....	26
7.3	Replacing the VM-810 Transmitter Batteries.....	26
7.4	Recharging the VM-850 Transmitter Batteries.....	27
8.	Glossary	28

1. Service & Support

1.1 Serial Number and Software Revision Number

Always quote your receiver and transmitter model number, serial number, and software revision number when requesting product support. They can be found as follows: (for reference only)

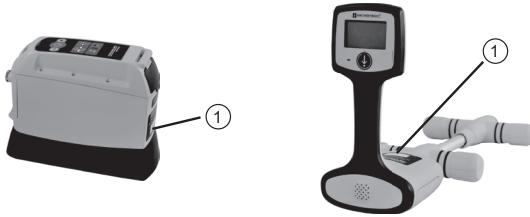

1	Model & Serial Number
---	-----------------------



NOTE

The transmitter Model & Serial Number can be found at the front of the transmitter.

Software Revision Number is displayed on the LCD during the startup.

1.2 Worldwide Sales Offices and Service Centers

Worldwide Sales Offices and Service Centers	
<p>World Headquarters, United States of America</p> <p>Vivax-Metrotech Corporation 3251 Olcott Street, Santa Clara, CA 95054, USA T/Free: 1-800-446-3392 Tel: +1-408-734-3880 Fax: +1-408-734-1415 Website: www.vivax-metrotech.com Email: SalesUSA@vxmt.com</p>	<p>Central/South America and the Caribbean</p> <p>Ventas para América Latina 3251 Olcott Street, Santa Clara, CA 95054, USA T/Free: 1-800-446-3392 Tel: +1-408-734-3880 Fax: +1-408-743-5597 Website: www.vivax-metrotech.com Email: LatinSales@vxmt.com</p>
<p>Canada</p> <p>Vivax Canada Inc. 41 Courtland Ave Unit 8, Vaughan, ON L4K 3T3, Canada Tel: +1-289-846-3010 Fax: +1-905-752-0214 Website: www.vivax-metrotech.ca Email: SalesCA@vxmt.com</p>	<p>France</p> <p>Vivax-Metrotech SAS Technoparc - 1 allée du Moulin Berger, 69130 Ecully, France Tel: +33(0)4 72 53 03 03 Fax: +33(0)4 72 53 03 13 Website: www.vivax-metrotech.fr Email: SalesFR@vxmt.com</p>
<p>Germany</p> <p>Metrotech Vertriebs GmbH Am steinernen Kreuz 10a, 96110 Schesslitz, Germany Tel: +49 9542 77227-43 Website: www.vivax-metrotech.de Email: SalesEU@vxmt.com</p>	<p>United Kingdom</p> <p>Vivax-Metrotech Ltd. Unit 1, B/C Polden Business Centre, Bristol Road, Bridgwater, Somerset, TA6 4WA, UK Tel: +44(0)1793 822679 Website: www.vivax-metrotech.co.uk Email: SalesUK@vxmt.com</p>
<p>China</p> <p>Vivax-Metrotech (Shanghai) Ltd. Building 10, Lane 1158 Zhongxin Rd., Songjiang District, Shanghai, China, 201615 Tel: +86-21-5109-9980 Website: www.vivax-metrotech.com Email: SalesCN@vxmt.com.cn</p>	

2. Introduction

2.1 VM-810/VM-850

This user handbook covers the use of the VM-810 and VM-850 cable and pipe location systems.

The Vivax-Metrotech Model VM-810, Radio Frequency Line Tracers are excellent instruments for tracing water and gas distribution lines, cables, inductive locating, and blind searching. The high-frequency signal of the VM-810 can jump insulators, and rubber gaskets often found in water and gas distribution systems. Since the radio frequency travels easily through the soil, the VM-810 is an ideal instrument for inductive locating. The floodlight quality of the RF signal will induce signal onto conductors 8-10 ft. on either side of the transmitter, making it an excellent instrument for blind searches. The lower frequency VM-850 is particularly useful in congested areas where it is essential to ensure as little bleed over to other conductors is minimized. It is most often used for power, telecommunications, CATV, oil, or gas applications.

The VM-810/VM-850 transmitter generates a signal which is applied onto the pipe or cable (conductor). The signal travels along the conductor, becoming weaker as it gets farther away from the transmitter. The distance that the signal travels before it becomes too weak to be detected depends on the method of connection, the type of conductor surrounding soil, and the depth of the conductor.

When positioned over the conductor, the receiver will detect the signal from the conductor. The Receiver's Left/Right Guidance System, field strength display, and audio tone aid you in tracing. To display the depth of the conductor, you simply push a button.

The Model VM-810/VM-850's automatic impedance matching compensates for differences in soil conditions, conductor size, and material.

As with all electromagnetic locating systems, this unit is designed to locate metallic conductors only. The word "conductor, pipe, or cable" refers to a metallic conductor throughout this user handbook.

The VM-810 and VM-850 operate in a very similar way. The main differences are:

VM-810 operating frequency is 83.0775 kHz

VM-850 operating frequency is 9.82 kHz

The VM-810 transmitter is powered from 6 x "D" cell alkaline batteries.

The VM-850 transmitter is powered from internal rechargeable Lithium-ion batteries. (Rechargeable batteries are used with the VM-850 transmitter. This is because the power drain from the lower frequency transmitter is much higher than that of the VM-810)



WARNING

Rechargeable batteries are supplied with a mains or 12V DC charger. These are specific to the batteries. Only use the charger that is appropriate for the batteries in the product. If in doubt, call Vivax-Metrotech Customer Service. Failure to use the appropriate charger could result in damage to the battery pack, locator, and in extreme cases, cause a fire.

Avoid charging the unit in extreme temperature conditions. (i.e., below 0°C and above 45°C)

Although Vivax-Metrotech batteries include all the required safety-related features, always immediately discontinue the use of the charger and battery pack if the battery pack becomes excessively warm. Return both to where they were purchased for investigation.

Always ensure batteries have at least a partial charge if storing for long periods without use.

Dispose of all batteries following your company procedures and Federal/State and local regulations.

Never dismantle batteries, put them in a fire, or get wet.



VM-810



VM-850

2.2 VM-810/VM-850 Receiver Controls and Indicators

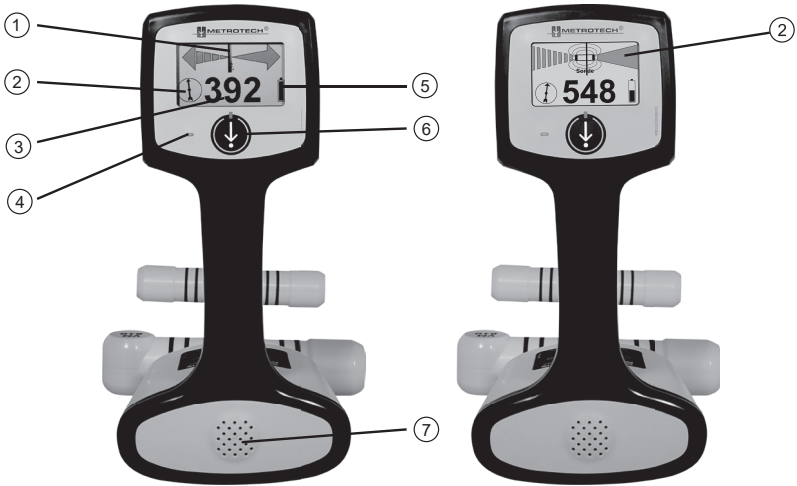

No	Item	Remark
1	Left/Right Guidance Meter	The centerline needle guides you toward the conductor. If the needle is in the right-hand (solid) portion of the meter, move the receiver to the right. If the needle is in the left-hand (broken) portion of the meter, move the receiver to the left.
2	Line/Sonde Direction Indicator	+/- 90°line/Sonde direction indication.
3	Digital Signal Strength Indicator	The signal strength is indicated on the LCD.
4	Automatic Backlight Sensor	Automatically senses when background light is low and switches on LCD backlight.
5	Battery Status	Continuous battery level indicator.
6	On/Off Plus Push Button Depth/Current/Sonde	Press to switch on, long press to switch off. A short press initiates push-button Depth/Current feature when the unit is switched on. Two quick short presses activate the Sonde mode.
7	Speaker	Audio tones are heard through the speaker.

2 Introduction



1	Battery Access Retaining Screw
2	Headphone Jack
3	Battery Holder
4	Rubber Cover

Headphone: Impedance 8ohms, Power rating 1 watt.

2.3 VM-810/VM-850 Transmitter Controls and Indicators

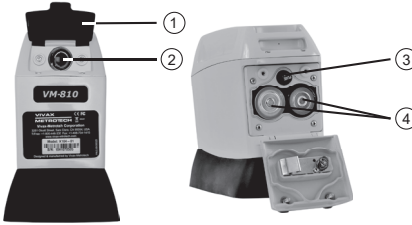

1	Rubber Weather Seal Cover
2	Direct Connection and Accessory Socket
3	Output Fuse
4	6 x "D" Type Cells

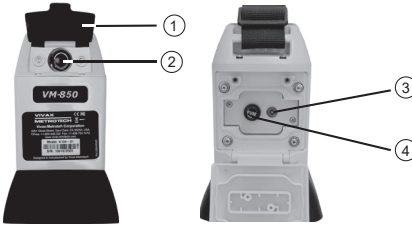

1	Rubber Weather Seal Cover
2	Direct Connection and Accessory Socket
3	Output Fuse
4	Charging socket

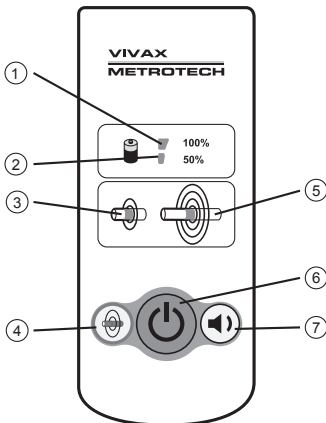

1	Battery Full Indicator
2	Battery 1/2 Full Indicator (Indicator flashes when the battery is nearing the fully discharged state.)
3	Low Output Power Indicator
4	Output Power Select
5	High Output Power Indicator
6	On/Off
7	Speaker Volume Select



NOTE

The battery indicator will flash when the battery level nears a fully discharged state. At this time, if not already set, the output will automatically switch to low output to conserve the remaining battery charge.

3. Check-Out Procedure

3.1 Introduction

To ensure proper operation of the VM-810/VM-850 Line Tracer, use the checkout procedure below at the following times:

- Upon receiving the equipment
- Before each job, preferably before you leave for the site
- If problems arise during a locate

Checkout Steps:

1. Turn the transmitter ON by pressing the ON/OFF button.
2. The LED indicators will illuminate, indicating that the transmitter is active.
3. Fully extend the receiver antenna by loosening the nut on the stem assembly and extending the stem as far as possible.
4. Switch the receiver on by pressing the ON/OFF button. Check that there is at least 25% of the battery remaining.
5. Position the receiver as shown in below. The digital signal strength indicator should display 950 or above.



Position of the Receiver for Checkout Procedure, Step 6

6. Now move the receiver back from the transmitter 3-6ft (1-2m). Point the receiver at the transmitter, as shown above, the Left/Right Guidance needle will be centered on the meter, and the tone will be silent. Note that the "Line Direction" indicator should be pointing directly at the transmitter.
7. Point the receiver to the left and right of the transmitter centerline. The needle should follow the change in direction (solid arrow and continuous tone when you move right, broken arrow, and broken tone when you move left).

3 Check-Out Procedure

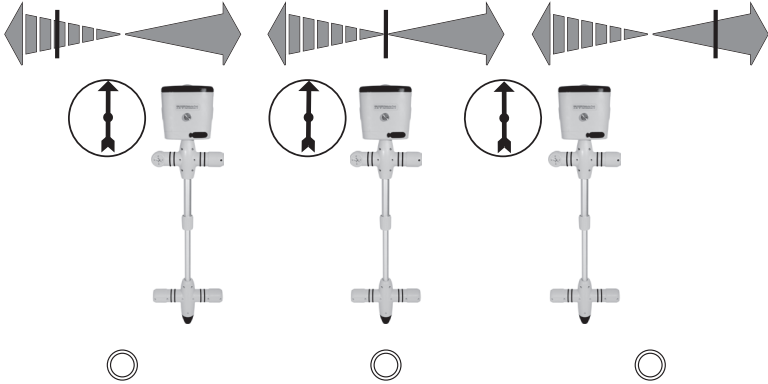

Checkout of Receiver Directional Meter

8. Rotate the receiver through 90 degrees. Check the compass (line direction indicator) is still pointing at the transmitter.
9. Center the needle on the meter as in Step 7.
10. When the needle is centered, press and release the DEPTH button, a depth reading should appear.
11. Turn the transmitter OFF by press and hold the ON/OFF button.

To test the conductive attachment for loose or broken wires:

1. Connect the BLACK and RED ends of the conductive attachment to each other. Lay the connected wires out on the floor in a circular configuration, as shown below. Plug the conductive attachment into the direction connection socket of the transmitter.



Configuration for Testing the Conductive Attachment

3 Check-Out Procedure

2. Turn the transmitter on and set to low output power.
3. Place the receiver tip directly on one of the conductive wires.
4. The signal strength reading should be above 700 constant and not fluctuate.
5. While watching the signal strength readout, wiggle each connection point on the conductive attachment at the direct connection socket and the clamp end of each of the conductive attachment wires (red and black). The signal strength should not change. Any fluctuation in the reading indicates a loose or broken wire within the conductive attachment.
6. Repeat step 6 on the other conductive wire.
7. Turn the transmitter OFF.

4. Operation

Follow the checkout procedure described in Section 3 before operating the equipment.

To operate the VM-810/VM-850 Line Tracer, use the VM-810/VM-850 transmitter to apply a signal to the conductor, and use the VM-810/VM-850 receiver to trace the signal.



DANGER – ELECTRICAL SHOCK

When making a direct connection to a live power cable, always be sure the power to the cable is turned OFF by using a voltmeter to check for active electrical power. (Live secondary power can be located safely using an Inductive clamp.)



WARNING – ELECTRICAL SHOCK

The VM-810/VM-850 transmitter generates up to 65 volts RMS. To avoid electrical shock, handle the conductive leads one at a time when the transmitter is ON.



CAUTION – INACCURATE INFORMATION

Do not operate the transmitter while it is resting on or near a metal surface or large metal object. Incorrect test readings and damage to the transmitter may result.

There are three different methods of applying the signal to the conductor with one of the transmitters – Direct Connection, Inductive Coupling, and Inductive. A description of each method and use instructions follow below:

4.1 Transmitter – Direct Connection

It is the preferred mode of operation because the transmitter is connected directly to a metallic part of the conductor (hydrant, meter, riser, valve, sheath, tracer wire), allowing a robust maximum signal to reach the conductor. In this operating mode, the receiver can be closer to the transmitter. Adjacent buried conductor interference is reduced.



NOTE

It is possible to set the output power to low or high settings. Always try to locate the target in the low setting first. This ensures that there is minimal bleed over to other services and will prolong the life of the battery. If the signal is too weak or unstable, set the transmitter to high power and try again.

4 Operation

1. With the transmitter OFF, plug the direct connect lead into the direct connection socket of the VM-810/VM-850 transmitter.
2. Attach the RED lead to an electrical clean metallic part of the targeted conductor.
3. Move the transmitter away from the conductor in a right angle direction, as shown below.

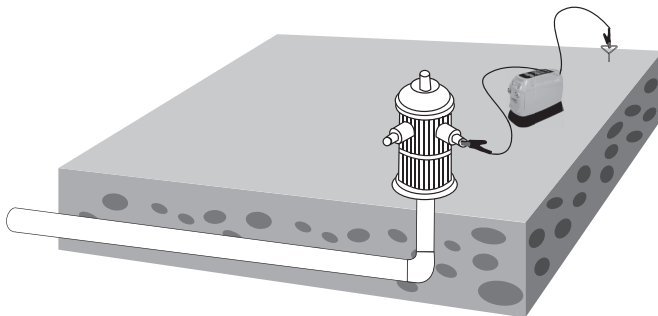

Direct Connection

4. Extend the BLACK lead of the direct connect lead as far as possible from the transmitter, maintaining the right angle orientation. At this point, push the ground stake into the ground as far as possible, and attach the BLACK lead to it.
5. Press the ON/OFF button on the transmitter to switch ON.
6. Trace the signal with the receiver.

4.2 Transmitter – Inductive Coupling

Use this method if Direct Connection is not possible, but you can position a signal clamp around the conductor you want to trace. The Inductive Coupling method uses a signal clamp to induce a signal onto the conductor when direct metallic contact is not possible. The clamp is placed around the target conductor. The transmitter then induces a signal through the clamp.

For best results, when using the signal clamp, the conductor should be well-grounded at both ends. When tracing lines that have insulators, it is best, but not essential, that the insulators be bypassed using jumper cables. Bonding and grounding at termination is often “standard practice” in industries that use cable, but do not assume this to be the case.

1. With the Transmitter OFF, plug the signal clamp cable into the direct/signal clamp jack.
2. Place the signal clamp around the conductor below the electrical ground. See the graphic below. Make sure that the clamp jaws are completely closed.
3. Follow steps 3 through 6 under "Direct Connection."
4. Trace the signal with the receiver.

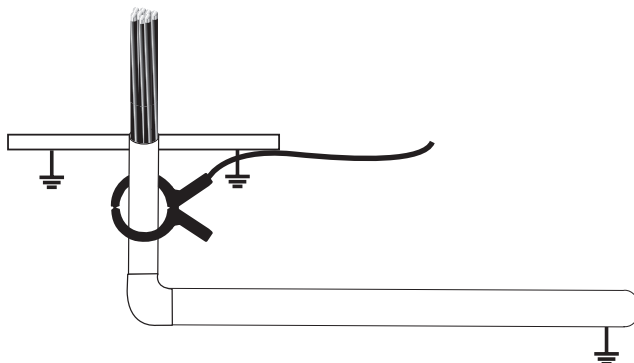

Inductive coupling with the signal clamp

4.3 Transmitter – Inductive Method

If you cannot make a direct connection onto the conductor or use the signal clamp, use the internal antenna of the transmitter to induce signal onto the conductor. See the graphic below.

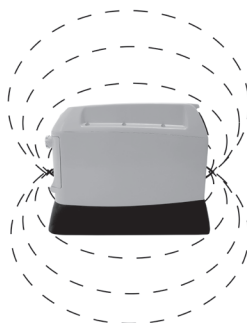

Signal Field Generated by Transmitter when in Inductive Use

This is the least preferred method of inducing signal onto a conductor because the signal is broadcast through the soil and the air and can be picked up by other conductors in the area. The signal radiates from an antenna inside the transmitter and couples to the conductor by electromagnetic induction.

1. Position the transmitter over the target conductor at a place that is at least 30ft. away from where you will be searching with the receiver. (If the transmitter is very close to the receiver, more signals may reach the receiver by air coupling than by coupling through the conductor). Place the transmitter across the buried conductor, as shown below.
2. Switch on the transmitter.
3. Trace the signal with the receiver, as described in the following section. To determine if you are air coupling, raise the receiver above the target conductor. If the signal does NOT decrease, you are air coupling. Move further away from the transmitter.

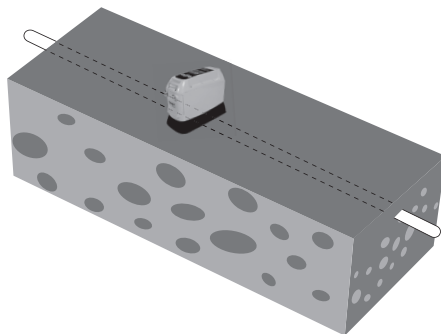

Position of a transmitter for inductive use

4.4 Using the Receiver

The following describes using the receiver with any of the three methods of applying the transmitter signal.



Position of Receiver for Tracing

1. Loosen the nut on the Receiver stem assembly and extend the stem as far as possible. Tighten the nut to secure the stem.
2. Turn on the Receive.
3. Go to the search area. Hold the receiver in a comfortable position in front of you and sweep the area, moving the receiver from side to side.
4. If the locator is within range of the signal radiating from the target line, the compass (line direction indicator) will align itself such that it is pointing in a parallel direction to the cable. Rotate the locator so that it is pointing forward.
5. Use the Left/Right Guidance, signal strength, and audio tone will guide you toward the conductor keeping the compass (line direction indicator) pointing forward. The needle on the Left/Right Guidance meter will move to the right, and the tone will be steady if the conductor is to your right. The needle will move to the left, and the tone will pulse if the conductor is to your left. The signal (or field) strength on the digital display (LCD) will rise as you approach the conductor.

4 Operation

As you close in on the location of the conductor, the meter needle will move toward the center, the signal will peak, and the tone will be silent. See the graphic below.

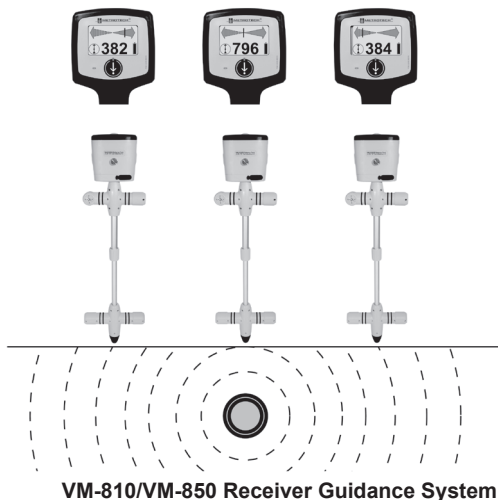

6. To determine the direction of the conductor, touch the Receiver tip to the ground over the conductor and rotate it on its vertical axis. Stop when the compass (line direction indicator) is pointing forward. This coincides with the highest signal strength reading.
Continue to trace the conductor in the direction indicated by the compass (line direction indicator). If the signal strength drops abruptly, the conductor may have changed direction or stopped.
7. When you have pinpointed the conductor's location, mark it as required. See Section 5.7 for APWA color markings.
8. When you have finished the locate, turn the receiver OFF, loosen the nut and retract the Receiver stem.
9. Turn the transmitter OFF and put all components back into the carrying case.

4.5 Determining the Depth and Signal Current applied to a Conductor

The VM-810/VM-850 can be used to determine the approximate depth of a conductor carrying a signal current. It is also possible to measure the signal current at a particular point along the conductor. It should be expected to experience a slow reduction in Signal current as the distance from the transmitter is increased. However, a dramatic or sudden change can indicate the operator has strayed from the target line or if there has been a "T" connection missed.

To accurately determine the depth and current of a conductor, the VM-810/VM-850 field strength must be strong enough to provide a stable meter reading. Keep in mind that depth and current measurements are affected by overhead lines, adjacent conductors, and abrupt changes in direction or depth. In congested areas, it is preferable to use Direct Connect when determining depth.

4 Operation

1. First, determine the location of the conductor using any of the methods described above (Direct Connection, Inductive Coupling, or Inductive Method).
2. Make sure the Receiver antenna is fully extended; otherwise, the depth reading will be incorrect.
3. Facing in the direction of the conductor, touch the antenna tip to the ground directly above the conductor, with the receiver at right angles to the ground. See the below graphic.

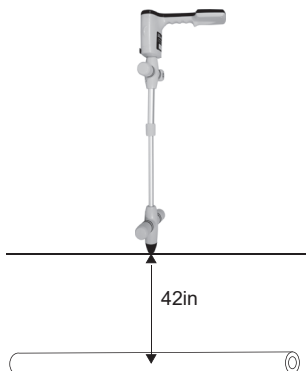

4. Press and release the DEPTH BUTTON on the handle of the receiver. Within seconds, the digital display will show the depth of the conductor in inches or centimeters, depending on the instrument version.

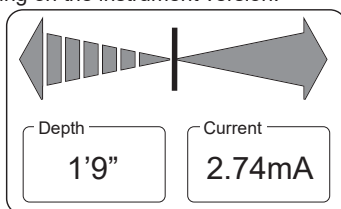

5. If the locator is not directly over the target line, the depth may not be displayed, and an error message displayed instead. An example of the Error message is shown below.

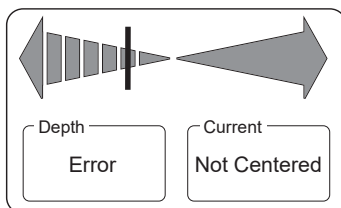

**NOTE**

The accuracy of depth and current readings depends on the quality of the radiated signal being located. If the signal is not distorted, the depth reading will be accurate to within 5% of the actual depth. If the signal is distorted, depth readings will be less accurate. When taking depth measurement, always hold the receiver in line with the line and at 90° to the ground.

4.6 Sonde Mode

A Sonde is typically used for locating non-metallic pipes or ducts. The Sonde operating frequencies for the 800 series are:

- VM-810 operating frequency is 83.0775 kHz
- VM-850 operating frequency is 9.82 kHz

4.6.1 Checkout Procedure for Locating Sondes

To ensure proper operation of the Model VM-810/850 Sonde and Utility Line Locator, use the checkout procedure below at the following times:

- upon receiving the equipment
 - before each job, preferably before you leave for the site
 - if problems arise during a locate
1. Switch on the receiver. Double click the on/off button to activate Sonde mode. Check battery status.
 2. Switch on Sonde and place on the ground away from metal objects such as rebar.
 3. Position Receiver within one foot or so of the Sonde and check high signal strength reading on the receiver. The receiver displays higher signal strength when over the Sonde.

4.6.2 Operation in Sonde Mode

1. Energize the Sonde – ensure batteries are in good condition and place in Sonde. Switch Sonde “ON.”
2. Check Sonde is transmitting - Position Receiver within one foot or so of the Sonde and check high signal strength reading on the receiver. Note Receiver displays higher signal strength with over Sonde.

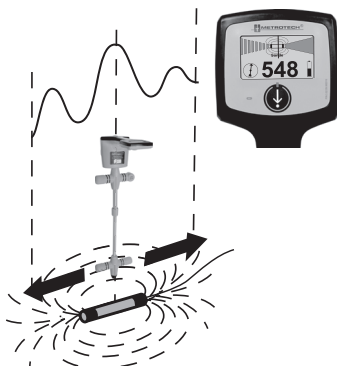

4 Operation

3. Position the Sonde in the pipe – attach Sonde to a flexible rod and insert it into the pipe. Position three feet or so along the length of the pipe.
4. To locate Sonde – With the tip of the receiver along the direction of the length of the Sonde, follow the Distance Sensitive Left/Right Guidance™ and audio output to locate the highest signal strength vertically above the Sonde. Note ghost signals immediately ahead of and behind the true signal (see figure). Now move the Sonde 10 feet along the length of the pipe and relocate Sonde as above. Repeat until Sonde is located in the desired position.

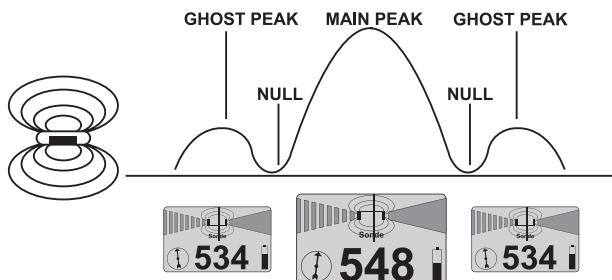

5. Determining the depth of the Sonde - Keep in mind that depth measurement is affected by soil conditions, overhead lines, adjacent conductors such as rebar, etc. which distort the field produced by the Sonde. Position yourself directly over the Sonde - make sure the tip of the receiver is parallel to the length of the Sonde. Hold the receiver vertically over the Sonde with the tip on the ground. Push and release the on/off button. The LCD will display the depth in feet and inches (or meters) for 3 seconds and then revert to the signal strength display.

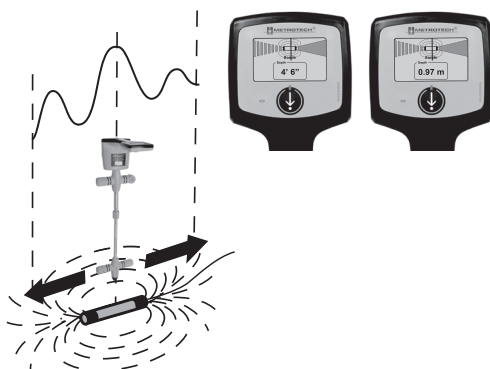

4.6.3 Sonde Location

A Sonde is a transmitting coil, and its signal radiates differently than that of a line (see diagram b).

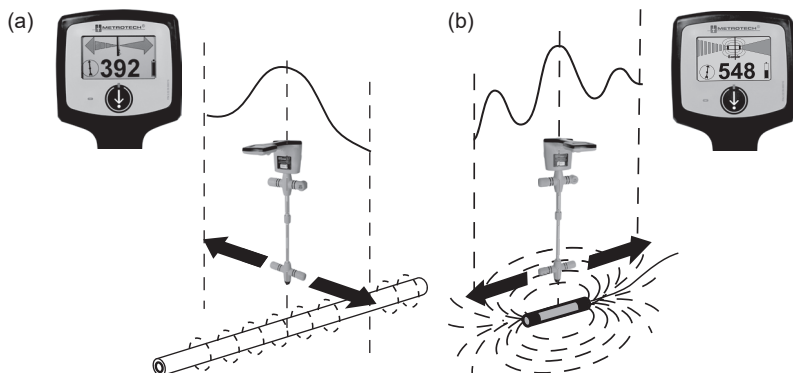

Due to this construction, the Sonde gives a different “Peak” pattern (see diagram b) – note that there are three distinct peaks – a small peak – a large peak – a small peak. The Sonde is located under the center of the “large peak,” when locating across the direction of the Sonde, it provides the normal peak response. Note also that the Sonde Direction Indicator points across the line of the Sonde when the receiver is directly over it.

A Sonde is typically used for locating non-metallic pipes or ducts. The Sonde operating frequencies for the 800 series are:

- VM-810 operating frequency is 83.0775 kHz
- VM-850 operating frequency is 9.82 kHz

The procedure for Depth Measurement is the same as the inline location but must be done in the Sonde mode. Depth measurements taken from a Sonde in any mode other than Sonde mode will be inaccurate.

4.6.4 Using the Sonde Direction Feature to Locate Sondes

Switch on the 810/850 by pressing the ON/OFF button. Then press the button twice quickly to activate the Sonde mode.

Stand in the approximate vicinity of the Sonde. If the signal strength is weak and the Left/Right guidance indicator is fluctuating, it means that the Sonde is not in the expected vicinity. If this is the case, pull back the Sonde to a known position, which may be the point the Sonde enters the pipe, and start the search here.

Rotate the locator until the Sonde direction indicator is pointing at 12 o'clock. Walk in the direction of the Sonde direction indicator keeping the direction indicator pointing at 12 o'clock. The locator will lead you in an arc that crosses over the Sonde. The maximum numerical signal strength and the centerline indicate the position of the Sonde.

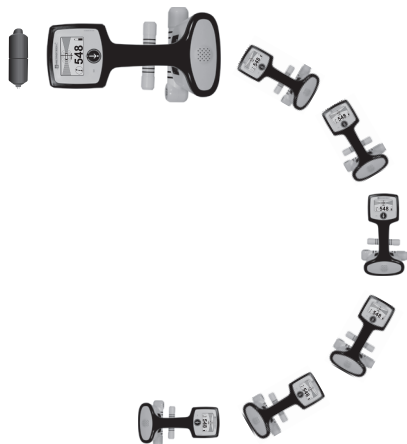

To pinpoint the Sonde, find the maximum numerical signal strength in both directions.

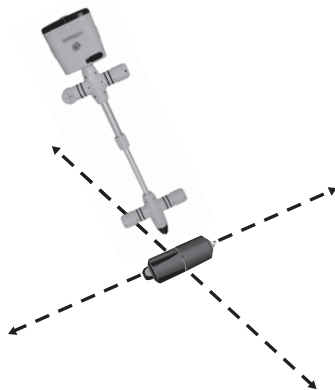

When over the Sonde, press the On/Off button once to display the depth reading.

TIP

Using the Sonde direction indicator to locate the Sonde requires free space to walk to the side of the Sonde. When dealing with obstacles, such as a wall or vehicle that restricts walking in an arc, the following method can be used.

- Position the locator in the approximate vicinity of the Sonde as above.
- Rotate the locator so that the direction indicator is now pointing at 3 o'clock.
- Now step to the side, keeping the locator pointing in the same direction. The direction indicator will rotate slightly.

Keep the locator pointing in the same direction and walk forward. The direction indicator will slowly rotate. When it reaches 12 o'clock follow the direction indicator keeping it at 12 o'clock.

5. Ground Survey Procedure

5.1 Applications

Regulations at construction sites often require a ground survey before any excavation is undertaken in the presence of underground utilities such as power, telephone, CATV, gas, and water lines.

5.2 Locating Conductors

When undertaking a ground survey, use one of the three modes of operation (Direct Connect most accurate) to locate the known (if any) utilities and mark their location on the ground. Then, using the Inductive mode (Operation Section 5.3, Inductive Method), two operators – one carrying the transmitter, the other operating the receiver – move in parallel across and then down the survey area. (The operator with the receiver must move sideways, facing the second operator with the transmitter. The Transmitter operator faces the direction in which he is moving as shown in the picture below). The LCD reading on the receiver will indicate the presence of a conductor under the ground as the operator passes over it. Mark the location of each conductor along your survey path. After executing this procedure in both directions, go back and trace the path of each of the conductors you have marked.

5.3 Subdividing Large Search Areas

If you are working in a large search area, subdivide it into several smaller areas. Then sweep through each smaller area thoroughly before going on to the next one.

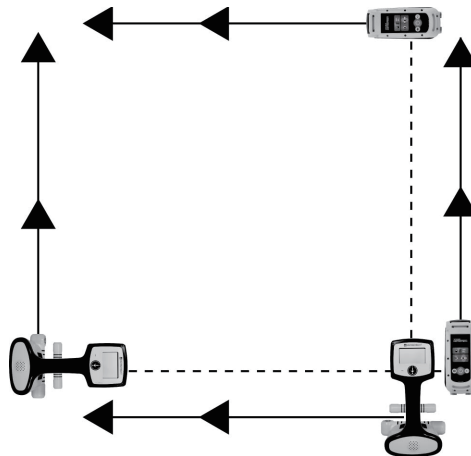

Locating Conductors: Parallel Pattern

6. Tracing Techniques and Helpful Information

Many variables affect the process of locating a pipe or cable. The following information gives guidelines for various problem situations.

6.1 *Soil Conditions*

Generally, the effect of soil types on line tracing is minimal. It should be possible to locate utilities in all soil types. However, soil conditions will affect the efficiency of grounding. It is essential to create good grounding to ensure efficient signal transfer to the target line.

6.2 *Adjacent Conductors*

If the field strength reading drops off more on one side of a conductor than it does on the other, the receiver may be picking up interference from an adjacent or parallel conductor. Confirm the exact location of the adjacent conductors. Place your ground lead so that it does not cross over any adjacent conductors, while being as far away from your target conductor as possible, and is extended perpendicular to the direction in which you are tracing.

6.3 *Signal Clamp: Ground Requirements*

If you are using the signal clamp around a cable, both ends of the target conductor must be grounded to ensure sufficient field strength. Power lines and telephone sheaths are assumed to be grounded.

If the conductor is a pipe which had an insulated joint, such as a gas pipe with a meter, use the jumper cable. Attach each end of the jumper cable on opposite sides of the insulator.

6.4 *Grounding: Safety*

If you use the Direct Connect method, be sure that there is no power flowing through the target conductor. If you use the signal clamp-on energized lines, follow established safety procedures.

6.5 *Distribution Systems*

To locate gas services on a gas distribution system, you must be sure that the service is grounded. This can be accomplished by temporarily connecting a jumper cable to a ground spike at the end of a service, where the pipe comes out of the earth.

6.6 *Deep Conductor*

Signals picked up by the receiver from deep-buried cables are weaker and not as directional distinct as those from cables closer to the surface. The meter reading will only change by small increments in relation to moving the Receiver antenna.

Using the Inductive (indirect) method of coupling signal to the conductor may be difficult if the target conductor is buried three feet or more or is set in new backfill.

6.7 What is the Field Strength of the Signal?

When the signal is applied to the conductor using any of the three methods described in Section 5, an electromagnetic field is created on the conductor. The receiver measures the strength of this field, displaying it on the digital meter.

The field strength decreases as you move away from the target conductor and as you go farther away from the transmitter.

6.8 “Ghost” Conductor Due to Adjacent Conductor

If there is another conductor near the target conductor, it too may pick up the signal from the transmitter. When this occurs, there will seem to be a trace – a “ghost” trace – between the two conductors.

A ghost trace can be detected by noting the following:

1. When the Left/Right Guidance needle changes direction, and the tone changes from broken to solid or solid to broken, and the Left/Right Guidance meter needle moves in the same direction as you are moving. (Normally, the Left/Right Guidance needle moves in the opposite direction.)
2. The field strength reading will drop as you move toward the “ghost” conductor. (Normally, field strength would increase.)
3. If you take a depth measurement over a “ghost” conductor, you will get a random or “Error” reported.

The receiver reads a “ghost” conductor when each coil on each side of the cross-section of the antenna receives the same amount of signal from two separate conductors.

The location of the “ghost” will vary according to the size, depth, and conductivity of any adjacent conductors.

To re-establish the correct trace, backtrack, and search the area in a 180° arc.

6.9 Completing the Circuit Path

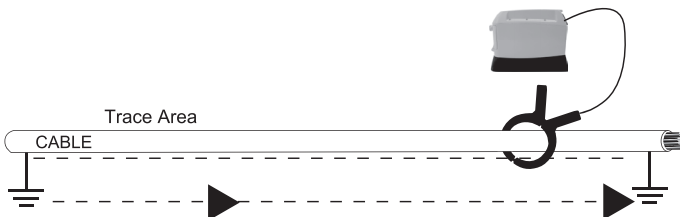

Ground on ether side of the trace area

The circuit path between the point at which the Transmitter signal couples to the conductor and where the receiver is being held over the conductor has to be complete. Otherwise, very little Transmitter signal will reach the receiver. If you suspect a break in the circuit path, look for disconnected leads, circuit breakers, and open switches. It is essential to provide good ground when setting up the transmitter.

Power lines and telephone sheaths are assumed to be grounded. If the conductor is a pipe that has an insulated joint, such as a gas pipe with a meter, use a jumper cable. Attach each end of the jumper cable on opposite sides of the insulator.

6.10 Common Bonded Conductors

Telephone, power, and CATV sometimes use a common ground bond. If other conductors are connected to your target conductor, putting a signal on the target can cause all the conductors to carry the same signal. This makes it challenging to identify the target conductor.

To verify you are tracing the targeted conductor, note the current readings at a known location of the targeted conductor. As you trace, any change in current reading should be gradual. If reading changes abruptly, you are probably no longer over your targeted conductor or have passed an intermediate ground point or "T" connection.

6.11 Congested Areas

In an urban or otherwise congested locate area, it is not uncommon for water, gas, power, or telephone utilities to use conventional trenching. Every congested situation is different; there are too many variables for us to cover here. Use good judgment and locating skills to carefully determine where other conductors are in your locate area, and what effect they may be having on your tracing situation. Make use of comparison depth, field strength, and current readings to determine and confirm that you are tracing your targeted conductor.

If you suspect that coupling from adjacent conductors is causing interference in the signal picked up by the receiver, try increasing the strength of the signal received from the transmitter and decreasing the strength of the signal from the interfering conductors by:

1. Changing to a different transmitter coupling point or coupling mode.
2. Improving the grounding connection or moving the grounding point.
3. Determine the location of the adjacent conductors. Then check to be sure that neither the direct connect cable or the ground cable cross over any of the adjacent conductors. Re-position them if necessary.
4. If you are using the Inductive (Indirect) mode, you may be able to decrease the amount of interfering signal by changing the orientation of the transmitter to the targeted conductor. Determine the location of the interfering conductor. Place the transmitter, turned on its end with the bottom facing the targeted conductor, over the interfering conductor, as shown below.

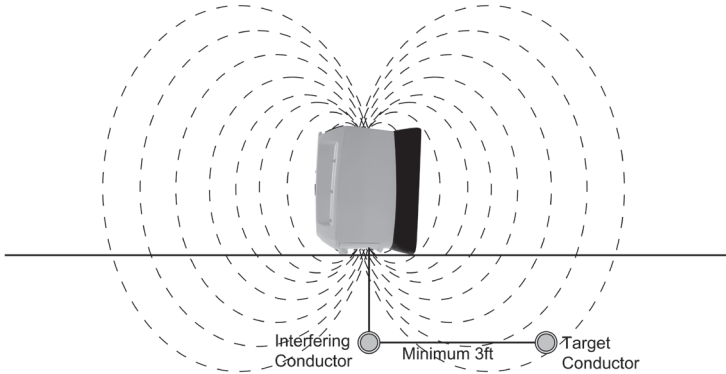

Position the transmitter for minimum interference

6.12 Locating a Service Lateral

After you have traced the main, you may want to go back and locate the service laterals off the main. Service lateral traces are easiest to conduct in the Inductive Mode. Two operators are required for this procedure – Operator 1 remains stationary holding the receiver as if to trace over and parallel to the main. Operator 2, carrying the transmitter (with the power on) and maintaining a minimum of 100ft/30m between himself and the receiver, walks parallel, but five feet from the main on the side, he expects to find the service laterals as shown in below. The field strength reading on the receiver will increase as Operator 2 crosses over the service lateral with the transmitter. Each time the field strength reading increases, Operator 1 signals Operator 2, and he/she marks the lateral location on the ground.

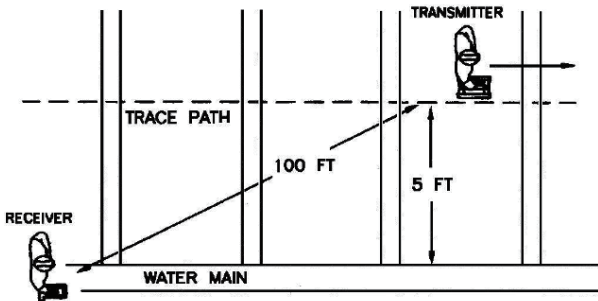

Locating Service Laterals

6.13 Valves, Manhole Covers, Tees and Risers

If the meter reading suddenly increases and then falls back while tracing a pipe, you have probably passed over a buried valve, manhole cover, tee, or riser.

7. Maintenance

7.1 VM-810/VM-850 Receiver Calibration

The centerline, signal strength, and depth of your VM-810/VM-850 receiver have been calibrated to factory specified tolerances. It is to your advantage to monitor the performance of your VM-810/VM-850 receiver on a weekly basis.

Vivax-Metrotech recommends using a known conductor of which you know both the location and the depth to test your VM-810/VM-850 receiver, for example, a buried service lone at your work location. If the receiver gives significantly different centerlines, signal strength, or depth information from what you know to be true, it should be re-calibrated by Vivax-Metrotech, or a Vivax-Metrotech authorized Service Center.

7.2 Replacing the VM-810/VM-850 Receiver Batteries

1. Have ready two D cell 1.5V NEDA 13A, IEC LR20 (Int'l Std), or JIS AM1 (Jpn Std.) type alkaline batteries.
2. Unscrew the retaining screw on the rear of the receiver.
3. Pull away the battery compartment from the receiver.
4. Unclip the two retaining lugs at the top of the battery holder allowing the lid to hinge back.
5. Remove the two spent batteries and replace them with fresh ones noting the polarity as indicated on the battery holder. Close the lid, ensuring the lugs have clipped into place. Return the holder to the receiver and hand tighten the retaining screw.

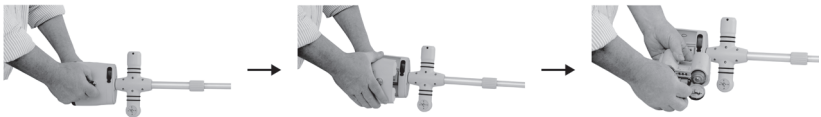

7.3 Replacing the VM-810 Transmitter Batteries

Check the VM-810/VM-850 Transmitter batteries by pressing the POWER ON button. The battery indicator lights will indicate if the batteries are good. If you need to replace the batteries, follow the steps below:



7 Maintenance

1. Have ready six 1.5V Alkaline batteries, size D NEDA 13A, IEC LR20 (Int'l Std), or JIS AM1 (Jpn Std.).
2. Unscrew the two retaining screws at the front end of the transmitter. Hinge the cover back to reveal the batteries.
3. Remove the old batteries and replace them with new ones, following the polarity orientation indicated on the transmitter.
4. Close the Transmitter lid and secure the two retaining screws. Hand tightens only.



7.4 Recharging the VM-850 Transmitter Batteries

Check the VM-810/VM-850 Transmitter batteries by pressing the POWER ON button. The BATTERY indicator lights will indicate if the batteries are charged. If you need to charge the batteries, follow the steps below:

1. Connect the charger to the transmitter, as shown below. Connect the charger to a main 110 or 240V AC socket.
2. Switch on the mains supply.
3. The indicator will illuminate red until a full charge of the batteries is achieved. This can take up to 8 hours.
4. Switch off the mains supply and remove the charger.



8. Glossary

Active Locate	A locate where a transmitter is used to apply a signal to a buried pipe or cable, the position of which is then located by a receiver tuned to the same frequency.
Active Signal	A signal applied by the locator transmitter to a buried line. Typical, this is an exact frequency.
Attenuation	The reduction of an electromagnetic signal from a pipe or cable.
Clamp (or Coupler)	An accessory used to apply the transmitter signal to an insulated line, removing the need to connect the transmitter signal directly to a conductor or cable sheath.
Compass	Line direction indicator (although visually like a compass, this is the only relation to a compass.)
Coupling	The act of signals transferring to lines to which they were not originally applied. Coupling can be "direct" where the target line has an electrical connection to another line, or "induced" where the signal radiates from the target line to another line or lines.
Display	The information visually available on the dot matrix display.
Line	A generic term for any buried pipe or cable.
Null	A minimum response to a buried line. 
Passive Locate	A locate where the receiver searches for a wide range of signals that radiate from buried pipes or cables. These signals come from a variety of sources in the environment and couple to the buried (& overhead) lines. Typical examples 50/60Hz and LF/VLF radio.
Passive Signals	A wide range of signals that radiate from buried pipes or cables. These signals come from a variety of sources in the environment and couple to the buried (& overhead) lines. Typical examples 50/60Hz and LF/VLF radio.
Peak	A maximum response to a buried line. 

8 Glossary

Pinpoint	Using a receiver to identify the exact position of a buried line.
Response	The indication that the receiver gives which is caused by the signals it is receiving. This can be visual, audio, or both. Typically, it is displayed on the locator's dot matrix display and audibly from a loudspeaker in the receiver housing.
Search (sweep)	This describes the act of looking for a buried line within a given area.
Sonde	A small transmitting coil which may be built into a product such as a sewer camera or packaged as a small self-contained battery-powered transmitter. A receiver tuned to the same frequency can locate the position of the Sonde and hence whatever it is attached to or in. Frequently used for locating sewer cameras, and the non-metallic pipes.
Target Line	The buried pipe or cable to be located.
Trace	Using a locator to following the path of a buried line.

Illustrations used in the preparation of this manual will inevitably show some resemblance to similar illustrations from other manufacturers. Some manufacturers have permitted the use of their graphics is given credit for these use. This statement is intended to attribute such credit.

Disclaimer: Product and accessory specification and availability information are subject to change without prior notice.

Notes:



Vivax-Metrotech Corporation
3251 Olcott Street, Santa Clara, CA 95054, USA
Toll Free: 1-800-446-3392
Phone: +1 (408) 734-3880
Website: www.vivax-metrotech.com

