



VIVAX
METROTECH



vCam-6 Inspection System

User Manual

Vivax-Metrotech Corporation

4.04.000087 04/01/2024 V1.5

General Safety & Care Information

◆ Health and Safety

This equipment is primarily used for inspecting sewer pipes by professionals operating in the sewer and plumbing industry and maintained by professionals familiar with the health risks of maintaining equipment in a sewer.

Such professionals will be protected by their company's recommendations and work practices. If for any reason they are not, or are not familiar with such practices, please check our website or email SalesUSA@vxmt.com for a copy of the Health and Safety Document used by Vivax-Metrotech for employees involved in the demonstration, maintenance, and handling of sewer camera systems.

- Keep all electrical connections dry and off the ground.
- Be always aware of your surroundings. Cone off open utility holes and follow traffic control regulations.
- Use personal protection such as eyewear, rubber gloves, and non-skid safety shoes.
- **Do not** use the control module as a handle to move the reel. Remove the control module or use the steel handle that is part of the reel's frame.

◆ Worksite Safety

- Use your company's or other applicable safety codes and rules when using this equipment.
- **Do not** use this equipment in explosive areas – such as in the presence of flammable liquids, gases, and heavy dust.

◆ Equipment Safety

- **Do not** open the enclosures (housings) of the control module or camera heads.
- Opening the housings, control module, or camera head will void any warranty.
- Use only the leads supplied with the control module for AC or DC operation and charging.

◆ Batteries and Environmental Safety

Vivax-Metrotech products use four types of batteries:

- Alkaline batteries
- Ni-MH (Nickel Metal Hydride) – rechargeable
- Lithium-ion batteries – rechargeable
- Lithium metal batteries – (small non-rechargeable button cells for "clock" applications)

a. Alkaline Batteries (Sondes, Light Kits or Locators)

- When replacing the alkaline batteries – use only the size and type specified – **do not** mix battery types (rechargeable and alkaline).
- **Do not** mix partially discharged and fully charged cells in the same battery pack – **do not** mix old with new.
- Never attempt to charge alkaline batteries.

◆ The heat from camera head LEDs



The camera head may become hot when left on while not performing an inspection. Handle the camera head with care when it is sitting outside

of the pipe for extended periods. We recommend using the camera skid and turning down the LEDs. The camera LEDs will automatically turn off after 5 minutes of no activity. No activity is triggered by the pushrod drum not spinning after 5 minutes.

◆ High-Pressure Water or Pressure Washers



Do not use pressure washers to clean the reel or other camera system parts.

◆ Bleach and chemicals - Do not soak the termination parts or camera heads



Do not soak the spring termination parts or the camera heads in bleach or other chemicals.

◆ Intended Use

This product is designed to inspect sewer laterals and basic indoor and outdoor plumbing. This product is not designed for and should not be used to inspect oil or other petrochemical pipes.

◆ FCC & IC Statement

Please note that changes or modifications not expressly approved by the party responsible for compliance could void the user's authority to operate the equipment. This device complies with Part 15 of the FCC Rules. Operation is subject to the following two conditions:

- (1) This device may not cause harmful interference, and
- (2) This device must accept any interference received, including interference that may cause undesired operation.

This device complies with Industry Canada license-exempt RSS standard(s). Operation is subject to the following two conditions:

- (1) This device may not cause interference, and
- (2) This device must accept any interference, including interference that may cause undesired operation of the device.

Le présent appareil est conforme aux CNR d'Industrie Canada applicables aux appareils radioexemptés de licence. L'exploitation est autorisée aux deux conditions suivantes:

- (1) l'appareil ne doit pas produire de brouillage, et
- (2) l'utilisateur de l'appareil doit accepter tout brouillage radioélectrique subi, même si le brouillage est susceptible d'en compromettre le fonctionnement.

Under Industry Canada regulations, this radio transmitter may only operate using an antenna of a type and maximum (or lesser) gain approved for the transmitter by Industry Canada. To reduce potential radio interference to other users, the antenna type and its gain should be so chosen that the equivalent isotropically radiated power (e.i.r.p.) is not more than that necessary for successful communication.

Conformément à la réglementation d'Industrie Canada, le présent émetteur radio peut fonctionner avec une antenne d'un type et d'un gain maximal (ou inférieur) approuvé pour l'émetteur par Industrie Canada. Dans le but de réduire les risques de brouillage radioélectrique à l'intention des autres utilisateurs, il faut choisir le type d'antenne et son gain de sorte que la puissance isotrope rayonnée équivalente (p.i.r.e.) ne dépasse pas l'intensité nécessaire à l'établissement d'une communication satisfaisante.

◆ **5G WiFi IC Statement**

(i) the device for operation in the band 5150-5250 MHz is only for indoor use to reduce the potential for harmful interference to co-channel mobile satellite systems;

(ii) the maximum antenna gain permitted for devices in the bands 5250-5350 MHz and 5470-5725 MHz shall comply with the e.i.r.p. limit; and

(iii) the maximum antenna gain permitted for devices in the band 5725-5825 MHz shall comply with the e.i.r.p. limits specified for point-to-point and non point-to-point operation as appropriate.

(i) Les dispositifs fonctionnant dans la bande 5150-5250 MHz sont réservés uniquement pour une utilisation à l'intérieur afin de réduire les risques de brouillage préjudiciable aux systèmes de satellites mobiles utilisant les mêmes canaux.

(ii) le gain d'antenne maximal autorisé pour les appareils dans les bandes 5250-5350 MHz et 5470-5725 MHz doivent respecter le pire limiter; et

(iii) le gain d'antenne maximal autorisé pour les appareils dans la bande 5725-5825 MHz doivent respecter le pire limites spécifiées pour le point-à-point et l'exploitation non point à point, le cas échéant.

Table of Contents

1. Service & Support.....	1
1.1 Model and Serial Number Location.....	1
1.1.1 Control Module.....	1
1.1.2 Reels.....	1
1.1.3 Camera Heads.....	1
1.2 Firmware Revision Location.....	2
1.3 Request for Service.....	3
1.4 Worldwide Sales Offices and Service Centers.....	3
2. Introduction.....	4
2.1 Icon Gallery.....	4
2.2 The vCam-6 Inspection Camera System.....	6
2.3 Standard Equipment - Control Module.....	6
2.4 vCam-6 Control Module Overview.....	7
2.5 vCam Series Cable Reels Overview.....	9
2.5.1 Standard Equipment - Reels.....	9
2.5.2 Type-CP Standard Reel.....	10
2.5.3 Type-MX Mini Reel.....	11
3. Initial Control Module Setup.....	12
3.1 Initial Control Module Setup.....	12
3.1.1 Installing the Fuse.....	12
3.1.2 Charging the Internal Battery.....	12
3.1.3 The Interconnect Cable.....	12
3.1.4 About Control Module Settings.....	13
3.2 Navigating through the Setup Menu.....	13
3.2.1 Keyboard Keys used in the Setup Menu.....	13
3.2.2 Setting the Control Module Language.....	14
3.2.3 Setting the Default Storage.....	14
3.2.4 Setting the Distance Counter.....	15
3.2.5 Setting the Date, Time and Format.....	16
3.2.6 Setting the Sonde Frequency.....	17
3.2.7 Wi-Fi Administration.....	17
3.2.8 Setting the Reel Type.....	18
3.2.9 Restore the Factory Default Settings.....	19
3.2.10 Update the Control Module Firmware.....	19
3.2.10.1 Over-the-Air Updates.....	20
3.2.10.2 Manual Update by UBS Thumb Drive.....	20
3.2.11 Update the Control Module Start Screen.....	24
3.2.12 The About Screen.....	24
3.2.13 Video Out.....	25
4. Video Recording and Picture Image Capture.....	26
4.1 Overview.....	26
4.2 Main File Menu.....	26
4.2.1 File List Sub-Menu.....	27
4.2.2 File Option Sub-Menu.....	28
4.2.3 Media Select Sub-Menu.....	28
4.3 Video Recording and Playback Controls.....	29
4.3.1 Making a Video Recording.....	30
4.3.2 JPEG Image Picture Capture.....	31
4.4 Play Videos and View Pictures in the Control Module.....	31
4.4.1 View Picture Image Files.....	32

4.4.2 Renaming a Video or JPEG Image File.....	32
4.4.3 Copy, Move or Delete Videos and Pictures.....	33
4.5 File Format of SD Cards and USB Devices.....	34
4.6 Video Format.....	35
4.7 Troubleshooting Video Playback.....	35
4.8 Corrupt Video Files.....	35
5. Features Available During Recording.....	37
5.1 Voice Over.....	37
5.2 Volume Control.....	37
5.3 Display and Backlight Settings.....	37
5.4 On-Screen Status Bar.....	38
5.5 On-Screen Display (OSD Info).....	38
5.6 Camera LED Light Control.....	38
5.7 Text Writer.....	39
5.7.1 Introduction to the Text Writer.....	39
5.7.2 Keyboard Function Keys of the Text Writer.....	39
5.7.3 Text Writer Components.....	41
5.8 JPEG Image Capture.....	41
5.9 Digital Zoom.....	42
6. Wi-Fi.....	43
6.1 Wi-Fi Connection for App.....	43
7. Using the Cable Reels.....	44
7.1 Cable Reel Overview.....	44
7.1.1 Mounting the Control Module.....	44
7.1.2 Remove the Control Module.....	45
7.1.3 Pushrod Overview.....	46
7.1.4 Distance Counter Accuracy.....	46
7.1.5 Deployment of the Pushrod Cable.....	47
8. Camera Heads and Terminations.....	50
8.1 Parts of the Camera Heads.....	50
8.1.1 Camera Head Options.....	51
8.2 Spring Assembly Parts.....	52
8.2.1 Type-CP Spring Kits.....	52
8.2.2 Spring.....	52
8.2.3 Coiled Cable Assembly.....	52
8.2.4 Lanyard Set.....	53
8.2.5 Termination Parts List.....	53
8.3 Removing the Camera Head – D34 and D46 Series Cameras.....	54
8.4 Removing the Standard Reel's Termination Spring and Coiled Cable.....	55
8.5 Installing the Standard Reel's Coiled Cable and Termination Spring.....	55
8.5.1 Pre-check the Termination Parts.....	55
8.5.2 Pre-checking Steel Lanyards.....	55
8.5.3 Pre-checking the Coiled Cable Assembly.....	55
8.5.4 Pre-checking the Spring.....	56
8.6 Installing the D34 and D46 series Camera Heads onto the Type-CP Standard Reel.....	56
8.6.1 Install the Coiled Cable and Termination Spring.....	56
8.6.2 Pre-checking the Camera Head Before Installing.....	57
8.6.3 Pre-checking for Picture and LED Control.....	58
8.6.4 Pre-checking the Camera Base O-Ring.....	58
8.6.5 Pre-checking the Camera Glass Lens and LED Cover.....	58
8.6.6 Installing the D34 and D46 Series Camera Heads.....	58
8.7 Removing and installing the Type-MX Reels D18-HD and D26-HD Camera Heads.....	59
8.8 Removing and Installing the Spring Assembly.....	61

9. Camera Skids.....	62
9.1 Camera Skids.....	62
9.1.1 Camera and Spring Skids, Installing and Removing.....	62
9.1.2 Standard Skids, screw in setscrews, D18 series, D26-MX, D34 and D46 series.....	62
9.1.3 Standard Skids, Two-part clip together, D20-HD, D26-HD.....	63
9.1.4 Spring Skids, Clamp around camera spring.....	64
9.1.5 Guide Skids, Clamp around the camera head.....	64
10. Locating Sondes and Pushrod.....	66
10.1 Introduction.....	66
10.2 Applying a Locate Signal onto the Pushrod.....	66
10.3 Sonde and Camera Locating.....	67
11. Troubleshooting.....	68

1. Service & Support

1.1 Model and Serial Number Location

Always quote your camera system's model, serial, and software revision numbers when requesting product support.

1.1.1 Control Module

The vCam-6 Control Module model number and serial numbers are found on the back of the unit.

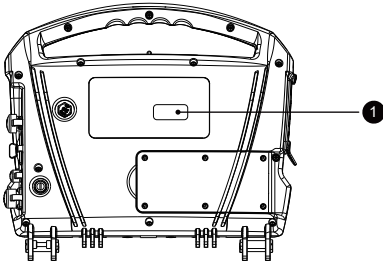

① Serial Number

1.1.2 Reels

The serial numbers for the vCam series reels are on the label at the center of the frame opposite the locking and friction brakes.

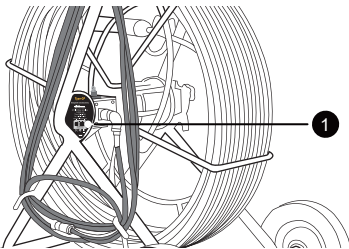

Type-CP Reel Standard Reel

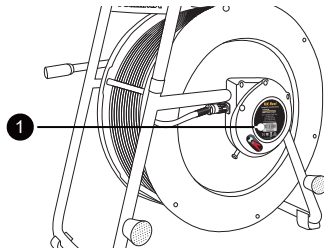

Type-MX Mini Reel

① Serial Number

1.1.3 Camera Heads

The camera head models combine the outside diameter of the camera head (less skid) and the type of reel termination it fits on.

D18-HD is 18mm / 0.76" in diameter and is used on the Type-MX Mini Reel.

D26-HD is 26mm / 1" in diameter and used on the Type-MX Mini Reel.

D34-HD and D34-C are 34mm / 1.3" in diameter and used on the Type-CP Standard reel.

D46-HD and D46-CP are 46mm / 1.5" in diameter and used on the Type-CP Standard reel.

Remove the standard skid to view the serial number of the camera head.

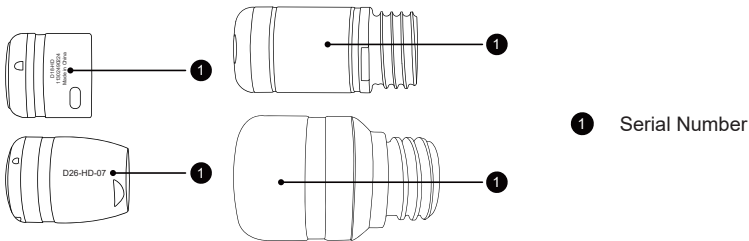

The camera's serial number is etched across the length of the camera or in the recessed area of the camera housing.

1.2 Firmware Revision Location

The "About" screen in the setup menu shows the control module's firmware (software) version and release date.

There are two types of firmware:

- DVR – for DVR recorder
- MCU – for microprocessor

1. Press the **F10 Menu** key twice on the control module keyboard to bring up the **Setup** menu.
2. Use the **down ↓ arrow** key to scroll down to the **About** selection.
3. Press **Enter** or use the **right → arrow** key to show the firmware version information.

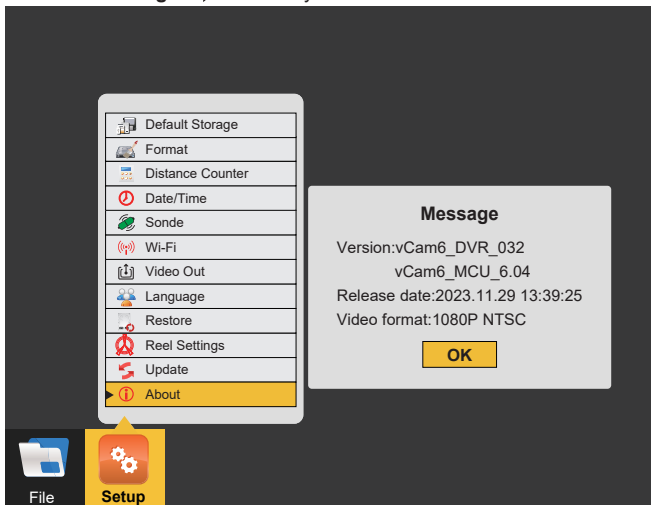

4. Press the **left ← arrow** key or **ESC** key three times to return to the **Setup** menu.

The firmware version can also be checked by connecting to the vCam Mobile Controller (VMC) app by going to **Settings**, then **About**.



1.3 Request for Service

If any system components need servicing, the more concise information provided will result in a quicker turnaround time. On our website, you can fill out a "Service Center Request" form, print it, and include it with the unit when shipping. Package the product well and ship it by a traceable method.

1.4 Worldwide Sales Offices and Service Centers

Worldwide Sales Offices and Service Centers

World Headquarters, United States of America

Vivax-Metrotech Corporation

3251 Olcott Street, Santa Clara,
CA 95054, USA
T/Free: 1-800-446-3392
Tel: +1-408-734-3880
Fax: +1-408-734-1415
Website: www.vivax-metrotech.com
Email: SalesUSA@vxmt.com

Canada

Vivax Canada Inc.

41 Courtland Ave Unit 8,
Vaughan, ON L4K 3T3, Canada
Tel: +1-289-846-3010
Fax: +1-905-752-0214
Website: www.vivax-metrotech.ca
Email: SalesCA@vxmt.com

Germany

Metrotech Vertriebs GmbH

Am steinernen Kreuz 10a,
96110 Schesslitz, Germany
Tel: +49 9542 77227-43
Website: www.vivax-metrotech.de
Email: SalesEU@vxmt.com

China

Vivax-Metrotech (Shanghai) Ltd.

Building 10, Lane 1158 Zhongxin Rd.,
Songjiang District, Shanghai, China, 201615
Tel: +86-21-5109-9980
Website: www.vivax-metrotech.com
Email: SalesCN@vxmt.com.cn

Central/South America and the Caribbean

Ventas para América Latina

3251 Olcott Street,
Santa Clara, CA 95054, USA
T/Free: 1-800-446-3392
Tel: +1-408-734-3880
Fax: +1-408-743-5597
Website: www.vivax-metrotech.com
Email: LatinSales@vxmt.com

France

Vivax-Metrotech SAS

Technoparc - 1 allée du Moulin Berger,
69130 Ecully, France
Tel: +33(0)4 72 53 03 03
Fax: +33(0)4 72 53 03 13
Website: www.vivax-metrotech.fr
Email: SalesFR@vxmt.com

United Kingdom

Vivax-Metrotech Ltd.

Unit 1, B/C Polden Business Centre,
Bristol Road, Bridgwater, Somerset,
TA6 4WA, UK
Tel: +44(0)1793 822679
Website: www.vivax-metrotech.co.uk
Email: SalesUK@vxmt.com

2. Introduction

User Manual Conventions



Read this section – This section is important and should be carefully read.



Stop – Read this section before proceeding.



Safety – Obey all safety messages that follow this symbol to avoid possible injury or death.



Note – Important information that will affect the performance of the product.























Tip – This tip may save you time or provide a better response.

2.1 Icon Gallery

This section lists the icons shown in the vCam-6.

Icon	Name	Description
Control Module Top Panel		
	Record	Press to Start and Stop a video recording. While recording, this icon flashes red.
	JPEG Capture	Press to capture a JPEG picture.
	Pause / Resume	Press pause the recording video. Press again to resume the recording.
	Microphone	Tap to activate the microphone to add audio comments to the recording video.
	Forward/ Rewind	Use it to move through the playing video.
	Play	Press to play a video in the control module.
	Stop	Press to stop a video playing in the control module.
	Zoom	Press to view 3 x zoom levels.
Front Panel		
	Camera Lights	Camera LED Dimmer - to raise, lower, or turn off the camera's LED lighting.
	Distance Reset	Distance Counter Reset - to reset the pushrod deployed distance to 0.

	Sonde	Sonde On/Off - and frequency selection control.
	Internal Microphone	Internal Microphone - to record audio comments over the video recording.
	Microphone	Microphone On/Off - glows red when the microphone is active.
	Charging Indicator	Battery Charging Indicator will glow red while charging and turn green when fully charged.
	Microphone Jack	3.5mm Microphone Jack - for use with an external microphone.
	Power	Power On/Off control.
Keyboard		
	ESC	Press to step back one level or exit.
	Help	It brings up an on-screen help menu.
	Info	Pressing this key moves the position or turns off the on-screen display.
	Ctrl + Info	Changes the color of the on-screen display.
	Text	Changes the text color.
	Ctrl + Text	Turns the text writer off and on.
	Background	Changes the screen text background.
	Recall	Recalls a page of saved text.
	Save	Saves a page of text.
	Del Page	Deletes a page of saved text.
	Del All	Deletes all pages of saved text.
	Display	Changes the display, backlight and touchscreen settings.
	Menu	To access the main and setup menus.
	Font	Changes the font type of the text writer.
	Wi-Fi	Turns the Wi-Fi on and off.

2.2 The vCam-6 Inspection Camera System

The vCam-6 Inspection System comprises three major components: vCam-6 Control Module, vCam Series Reels, and Camera Heads.

2.3 Standard Equipment - Control Module

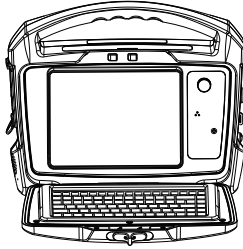

The below accessories will come with the vCam-6 Control Module.

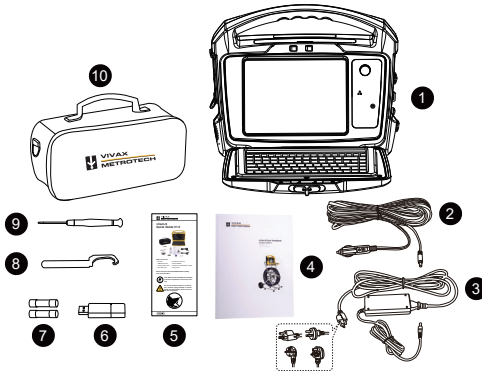

- | | | |
|----|------------------------------|--|
| 1 | Control Module | vCam-6 Control Module |
| 2 | 12V DC Power Cable | To power and charge the unit from a vehicle or 12V DC source. |
| 3 | Battery Charger | Power and charge the unit from a 120/240V AC power source. |
| 4 | User Handbook | With full operating instructions. |
| 5 | Quick Guide | With brief basic instructions. |
| 6 | USB Thumb Drive | For storing transferred videos and pictures. |
| 7 | 10 Amp, 250 Volt Fuse | Two fuses are supplied; one will need to be installed to allow the internal battery to charge. (And one spare) |
| 8 | Camera Removal Tool | Remove the camera head and termination spring on the Type-CP reel. |
| 9 | Flat Head Screwdriver | For use with standard camera skirts. |
| 10 | Accessory Bag | To hold all the accessories. |

2.4 vCam-6 Control Module Overview

The vCam-6 control module allows for the viewing, recording, and playback of Audio Video Interleave (AVI) format video and image capturing of Joint Photographic Experts Group (JPEG) pictures. Audio and text commentary can be added to the videos, and text commentary can be added to the captured pictures. The time stamping of the current time, date, and distance of the pushrod deployed can be added to both video and pictures.

The following describes the features and use of the control module:

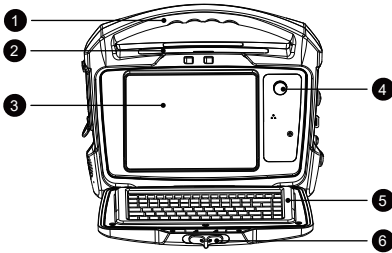

Control Module Front View

- ① Carry handle
- ② Recording, snapshot, zoom and video playback controls
- ③ 9.7" daylight viewable HD display (touch screen)
- ④ Power, distance reset, sonde, internal and external microphones and charging status indicator
- ⑤ Lid assembly with keyboard
- ⑥ Lock the lid latch to keep the lid closed.

Recording, Picture Capture, Playback, and Zoom Controls (top panel)

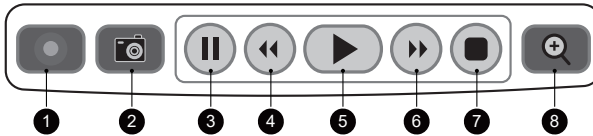

- ① **Start Recording** Use this key to start a recording. A red flashing recording icon will appear on the bottom-left section of the status bar on the LCD screen, and the elapsed recording time will appear in the bottom center.
- ② **Picture Capture** Use this key to take a jpeg picture from live video, the current recording session, or video playback. The picture icon will momentarily appear on the status bar, confirming that a picture was taken.
- ③ **Pause Recording** Use this key to pause the recording video. To resume recording, press the pause button again, and the recording icon will replace the pause icon.
- ④ **Rewind Video Playback** Use this key to rewind the currently playing video. Press up to three times again to increase the rewind speed.
- ⑤ **Play Video** Use this key while viewing videos recorded on the control module. Press to resume a paused video.
- ⑥ **Forward Video Playback** Use this key to forward through the currently playing video. Press up to three times again to increase the forward speed.
- ⑦ **Stop Recording** Use this key to end a video recording session or to stop a video being played in the control module.
- ⑧ **Digital Zoom** Use this key to zoom in on live, recorded, or JPEG pictures. Press one time to bring up the red zoom box on the screen. Move the zoom box to the area to be magnified and press the enter key. At the same time, the zoom box is shown press up to three times more to increase the digital zoom level.

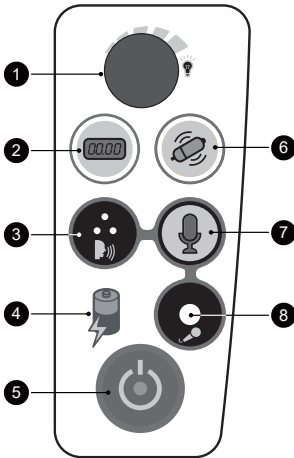

Front Panel Controls

- ❶ **Camera LED Dimmer** - to raise, lower, or turn off the camera's LED lighting.
- ❷ **Distance Counter Reset** - to reset the pushrod deployed distance to 0
- ❸ **Internal Microphone** - to record audio comments over the video recording
- ❹ **Battery Charging Indicator** will glow red while charging and turn green when fully charged.
- ❺ **Power On/Off** control
- ❻ **Sonde On/Off** - and frequency selection control
- ❼ **Microphone On/Off** - glows red when the microphone is active.
- ❽ **3.5mm Microphone Jack** - for use with an external microphone

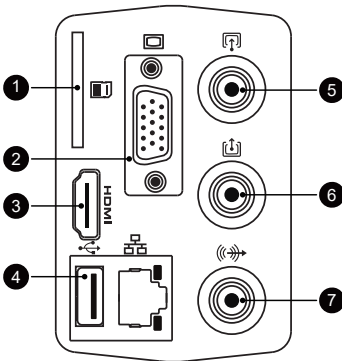

Media Ports (left side)

- ❶ **SD Card Slot** for transferring video or pictures to an SD card
- ❷ **VGA Port** to connect to an external display.
- ❸ **HDMI Port** to connect to an external display.
- ❹ **USB Port** is for transferring videos or pictures to a USB thumb drive.
- ❺ **RCA Video In Socket** will bring in video from an external source.
- ❻ **RCA Video Out Socket** to connect to an external monitor or other devices.
- ❼ **RCA Audio Out Socket** to connect to an external audio device.

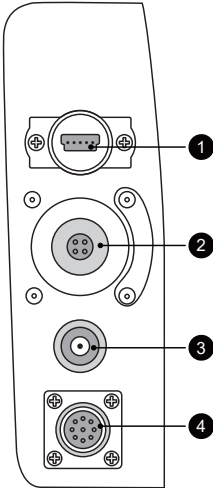

Interconnect Ports (right side)

- ❶ **USB Mini Data Port** allows for two-way communications with third-party observation software. It is used to export the distance out and the ability to change the distance in LACP software.
- ❷ **Camera Test Port** to help troubleshoot the D34 and D46 camera heads. A test lead is available to use the D18-MX and D26-MX camera heads.
- ❸ **AC/DC Power/Charging Socket** provides AC/DC power to power and charge the control module.
- ❹ **The Reel Interconnect Socket** connects the reel to the control module by the interconnect cable.

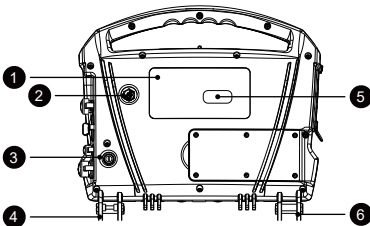

Control Module Rear View

- ❶ The **Model and Serial Number Label** will show the model, manufacturing date code, and serial number.
- ❷ The **Vent** allows warm air from the microprocessor to escape and vent the housing.
- ❸ The **Fuse Compartment** houses the fuse.
- ❹ **Reel Mounting Locking Pin** locks the control module atop the Type-CP Reel.
- ❺ The control module's **Serial Number**
- ❻ **Reel Mounting Pins** to attach to the Type-CP Reel

2.5 vCam Series Cable Reels Overview

The vCam series cable reels are used to store and control the deployment of the pushrod cable. The vCam series cable reels come in two sizes: a larger Type-CP standard reel, which is for day-to-day use, and a smaller, more portable Type-MX mini reel, which is used for small-diameter applications.

2.5.1 Standard Equipment - Reels

The Type-CP and MX reels include a pushrod with an installed termination spring assembly. The vCam-6 control module can be mounted and locked on top of the larger Type-CP reel, allowing viewing at a comfortable height.

All vCam series reels with pushrod are supplied with:

1. Interconnect Lead - The interconnect cable connects the reel to the control module and sends the raw video signal and distance of the pushrod deployed to the control module. This cable allows control of the sonde and camera head lighting from the control module.



2. Insertion Sleeve – The insertion sleeve is inserted into the mouth of the pipe to prevent the pushrod from making direct contact with the pipe when deploying. This prevents the chafing of the pushrod jacket, resulting in prolonged life.



2.5.2 Type-CP Standard Reel

The Type-CP standard reel is available in 200 ft. / 60m, 300 ft. / 90m, and 400 ft. / 120m of standard (12mm diameter) pushrod cable. The Type-CP reel includes 8-inch / 203 mm diameter solid rubber wheels for easy transport. The Type-CP reel can be used either in the vertical upright position or on its side in a horizontal position. The Type-CP reel has mounting brackets to lock the control module on top of the reel.

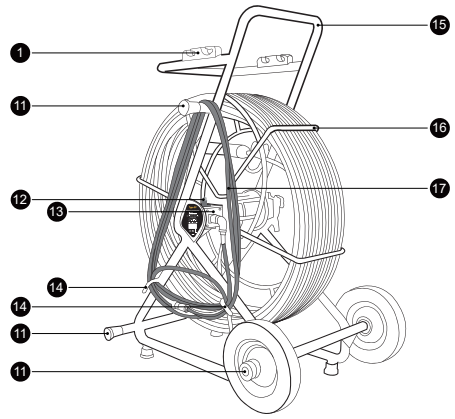
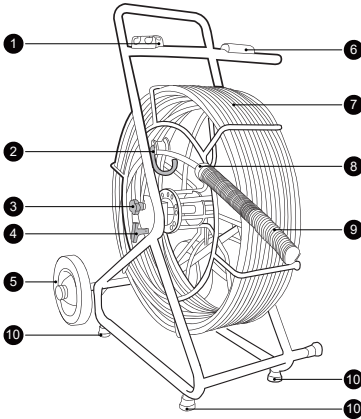

Type-CP Standard Reel

- | | |
|--|--|
| <ul style="list-style-type: none"> ① Mounting Blocks ② Cable Guide Assembly ③ Friction Brake ④ Locking Brake ⑤ Wheels ⑥ Keyboard Lid Resting Block ⑦ Pushrod Cable | <p>For mounting and locking the vCam-6 control module in place.</p> <p>It helps control the deployment and retrieval of the pushrod cable by keeping it in a localized area.</p> <p>To control the speed at which the cage spins.</p> <p>To lock the cage in place for transport.</p> <p>Tilt the reel by the handle and use the wheels for easy transport.</p> <div style="border: 1px solid black; padding: 5px; margin: 10px 0;"> <p>Do not use the control module as a handle to move the reel. Use the handle on the reel only.</p> </div> <p>When open, the control module lid rests on this block to keep it level.</p> <p>The Type-CP standard reel is available in 200 ft. / 60 m, 300 ft. / 90 m, and 400 ft. / 120 m of standard (12 mm diameter) pushrod cable.</p> |
|--|--|

- 8 **Sonde** The sonde locate signal emits from this cup. A utility or sonde locator with a matching frequency can pick up this locate signal on the surface.
- 9 **Spring Termination Assembly** It attaches to the pushrod and gives the flexibility to lead it through bends in the pipe.
- 10 **Rubber Feet, bottom** They help to keep the reel in place on slippery surfaces and to protect finished floors.
- 11 **Horizontal Position Legs** They allow the reel to be used on its side in a horizontal position.
- 12 **Pushrod Trace Post** Connect the hot lead of a utility locator transmitter to the rod trace post and the ground lead to earth to send a locate signal through the entire pushrod length.
- 13 **Counter Block Assembly** It contains the electronics used for distance counting and pushrod tracing. The serial number label is mounted to the side of the assembly.
- 14 **Cable Hooks** To store the interconnect cable in place when not in use.
- 15 **Reel Frame** Holds the cable cage in place and allows for easy reel transport.
- 16 **Pushrod Cable Cage** Houses the pushrod and allows deployment and retrieval of the pushrod.
- 17 **Interconnect Cable** It provides a control module to reel connection for video feed, sonde operation, distance counting, and camera LED lights.

2.5.3 Type-MX Mini Reel

The Type-MX mini reel is a smaller, portable, hand-carried reel available in 100 ft. / 30 m or 150 ft. / 45 m of mini (10 mm diameter) pushrod cable.

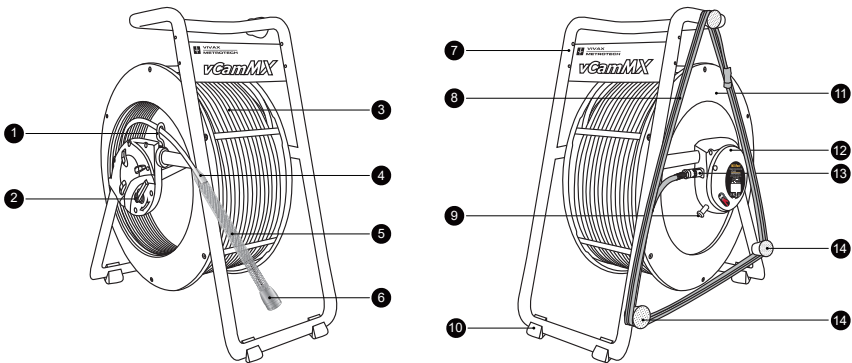

Type-MX Mini Reel

- | | |
|------------------------------|--------------------------------|
| 1 Cable Guide | 8 Interconnect Cable |
| 2 Friction and Locking Brake | 9 Rod Trace Post |
| 3 Pushrod | 10 Rubber Feet |
| 4 Sonde | 11 Frame |
| 5 Termination Spring | 12 Pushrod Reel Connection Hub |
| 6 Camera | 13 Interconnect Cable Socket |
| 7 Reel Drum | 14 Horizontal Position Feet |

3. Initial Control Module Setup

3.1 Initial Control Module Setup

3.1.1 Installing the Fuse

Install the 10 Amp - 250 Volt fuse in the fuse compartment on the back of the control module. The control module will operate without a fuse when using AC power, but the battery will not charge, and the unit will turn off when the AC power is removed.

The fuse holder is located at the bottom left-hand area on the back of the control module. Two 10 Amp 250 Volt fuses are included in the control module accessory bag, one for the unit and one spare.

1. Use a screwdriver to unscrew and remove the fuse holder cap. Use the correct size screwdriver to prevent breaking the fuse holder slot.

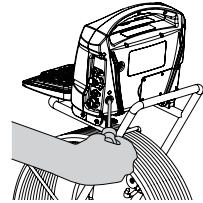

2. Insert the 10 Amp 250 Volt fuse into the fuse holder cap.

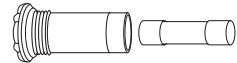

3. Screw the fuse holder cap with fuse into the control module by hand as far as possible, then use a screwdriver to tighten it.

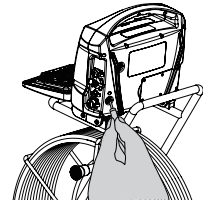

3.1.2 Charging the Internal Battery

Plug the supplied battery charger into a live electrical socket. The charging icon on the front panel of the control module will glow red while charging and green when fully charged. The typical charging time to fully charge a completely discharged battery will be approximately five hours and provide approximately five hours of use.

3.1.3 The Interconnect Cable

Plug the reel's interconnect cable into the control module to bring the video onto the screen. This is a key plug and socket, so line up the red dot on the interconnect cable plug to the same red dot on the interconnect socket on the control module. Pull back the knurled ring on the connector and insert it into the socket, releasing the knurled ring. Check that the connection is secure by giving a slight wiggle and tug. To remove the interconnect cable, pull back the knurled ring and pull the plug out.

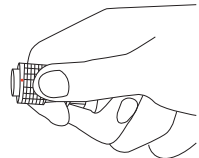

Keyed Connector

If a reel with a camera attached is not available or inconvenient, then plugging a camera head into the camera test port will have the same results.

3.1.4 About Control Module Settings

The initial setup of the vCam-6 control module is done with the keyboard. A USB or wireless mouse can also be used. All the settings selected are saved into the control module's memory and will remain until changed. Note that the settings will be lost if the unit is reset to factory defaults, running certain firmware updates, or formatting the hard drive. The reel and camera need not be connected to the control module for the first setup.

The initial control module will set the default storage for videos and pictures, metric or imperial distance measurement, date and time formats, sonde frequencies, language, and type of reel being used with the control module.

3.2 Navigating through the Setup Menu

Set your language first so all the other menus can be easily read and understood. See section 3.2.2, Setting the Control Module Language, on setting the system language.

If the control module is attached to a reel with a camera or a camera head is inserted into the camera test port, a video image will be shown on the screen. While working in the Main or Setup Menu, the video image will remain darkened.

The vCam-6 control module has two main menus: the File and Setup menus. Both main menus contain sub-menus.

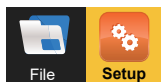

This section will concentrate on the **Setup Menu**.



Pressing the keyboard **F10** key once will bring up the **File** menu, and pressing twice will bring up the **Setup** Menu. Pressing the **ESC** key twice will close either menu and return to the main viewing screen.

3.2.1 Keyboard Keys used in the Setup Menu

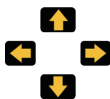

Directional Arrows:

Pressing the directional **up** ↑ and **down** ↓ arrow keys moves through the list of options in the **Setup** menu. As the **up** ↑ / **down** ↓ arrow keys are moved, the selection is highlighted in yellow. Stop on the desired option, then press **Enter** or use the **right** → arrow key to see the choices within the selected menu option.

Enter Key:

Pressing the **Enter** key will confirm the selected item. Furthermore, pressing the **Enter** key in a sub-menu will confirm the selection with a green check-marked box .



The green check-marked box is used in the Default Storage, Distance Counter, Sonde, Video Out, and Reel Selection Options.



ESC Key:

Pressing the **ESC** key in any menu or sub-menu will return the screen to the previous menu. Press the **ESC** key repeatedly to return to the main viewing screen.



This user handbook will cover each item in the Setup menu, starting with the Language sub-menu. Afterward, the user handbook will cover each item in the Setup menu order from top to bottom.

I.e., Language, Default Storage, Format, Distance Counter, etc.

Default Storage
Format
Distance Counter
Date/Time
Sonde
Wi-Fi
Video Out
Language
Restore
Reel Settings
Update
About

3.2.2 Setting the Control Module Language

1. Press the **F10 Menu** key twice to bring up the **Setup** menu.
2. Use the **down** ↓ arrow key to highlight the **Language** option.
3. Press **Enter** or use the **right** → arrow key to move into the sub-menu with the list of languages.
4. Use the **down** ↓ arrow key to highlight the desired language to use.
5. Press the **Enter** key to confirm the choice.

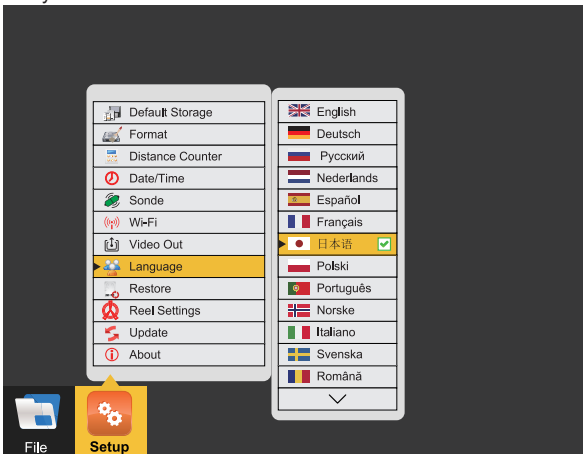

6. A dialog box will appear stating the system will reboot to complete the change.
7. Press the **Enter** key to select **OK** to complete the process. The control module will re-boot, and the language will be changed when it starts again.



The control module must reboot to make this change.

3.2.3 Setting the Default Storage

Setting the Default Storage selects which drive (SD, Hard Drive, or USB) will be the default. If the hard drive is selected, all video recordings and pictures will be saved to this drive. If SD or USB is selected as the default, this setting will be lost when the SD card or USB drive is removed from the control module.

1. Press the **F10 Menu** key twice to bring up the **Setup** menu.

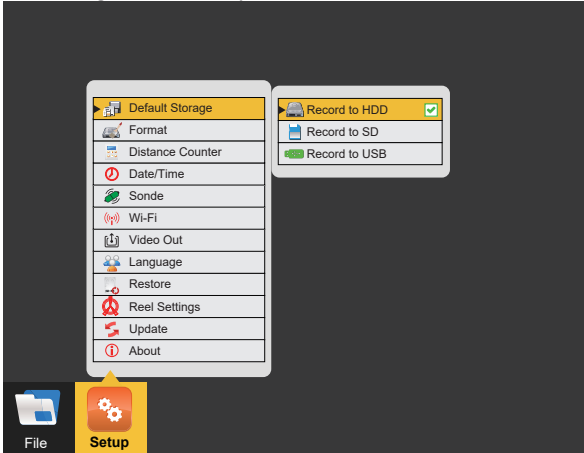

2. Select the **Default Storage** option at the top of the selection list.
3. Press **Enter** or use the **right**  arrow key to move to the sub-menu with the list of options.



SD and USB drives will only be shown if their devices are plugged into the control module at this time.



If the SD or USB drives are set as default, when the SD or USB is removed, the Hard Drive will be reset as the default drive.

4. Use the **down**  and **up**  arrow keys to select the default storage choice.
5. Press the **Enter** key when the choice is highlighted, and the white box will be filled with a green check confirming the selection.
6. Press the **ESC** key to return to the main **Setup** menu, and press the **ESC** key twice to return to the main viewing screen.

7. From the main viewing screen, press the **F10** key once to bring up the **File** menu. The selected default drive is shown at the top of the main File menu, along with the amount of free space available and the total drive size.

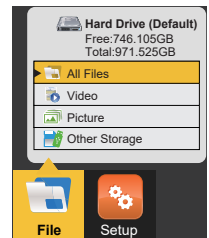



3.2.4 Setting the Distance Counter

The distance counter sets the unit of measurement to be used. The choices are imperial (feet) or metric (meters). The distance of the pushrod deployed will be shown on the main screen above the status bar and will appear in videos and pictures when this feature is activated using the **F2 Info** key.



The distance counter is for reference only. Before excavating, you must verify the actual position and depth with a Sonde Locator or Pipe & Cable Locator.

1. Press the **F10 Menu** twice to bring up the **Setup** menu.
2. Use the **down**  arrow key to scroll down to the **Distance Counter** selection.
3. Press **Enter** or use the **right**  arrow key to bring up choices of **Feet** or **Meters**.

- Use the **up** ↑ / **down** ↓ arrow keys to highlight the choice.
- Press the **Enter** key when the choice is highlighted, and the white box will be filled with a green check confirming the selection.

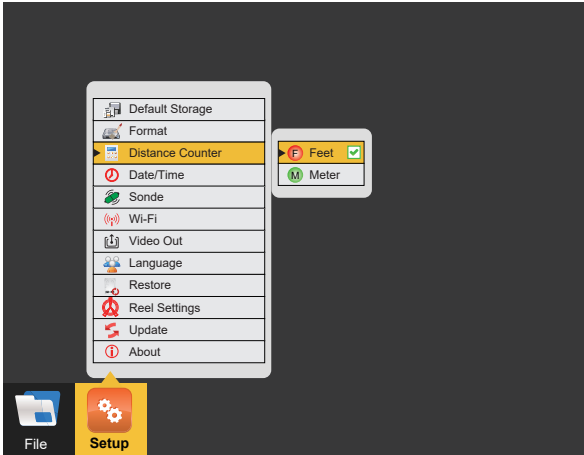

- Press the **ESC** key to return to the main **Setup** menu, and press **ESC** twice to return to the main screen.

3.2.5 Setting the Date, Time and Format

Setting the date/time allows the choice of three date formats, 12 or 24-hour time format, and sets the date and time of the control module. The date, time, and distance of the pushrod deployed will be shown on the main screen above the status bar and will appear in videos and pictures when this feature is activated using the **F2 Info** key.

Date formats available are: **MM/DD/YYYY**, **DD/MM/YYYY** and **YYYY/MM/DD**

- Press the **F10 Menu** twice to bring up the **Setup** menu.
- Use the **down** ↓ arrow key to scroll down to the **Date/Time** option.
- Use the **down** ↓ and **up** ↑ arrow keys to move between the three date formats. When the selection is made, and the red dot appears in the radio box, it is time to move to the time options.
- Navigate to the **OK** button and press the Enter key.

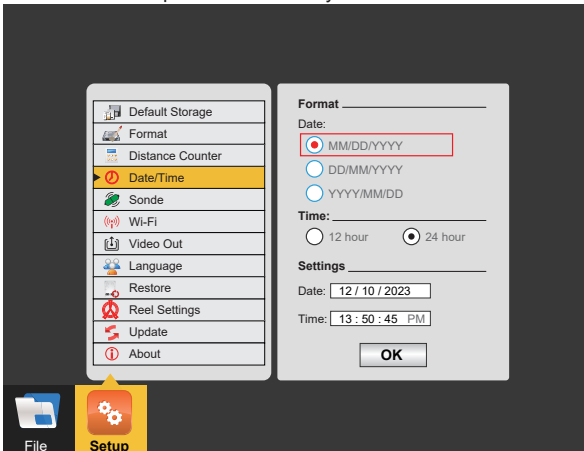



Pressing the **Enter** key at any time will save the changes made. This allows separate changes to be made at any time to the time, time format, or date without moving through all available selections.

3.2.6 Setting the Sonde Frequency

Setting the Sonde frequency allows the selection of either 33kHz, 512Hz, or 640Hz frequencies when the Sonde On/Off button is pressed. Typically, 33kHz or 640Hz is used in Europe and the UK, while 512Hz is used in North America. One, two or all three frequencies can be added to the control module.

1. Press the **F10 Menu** key twice to bring up the **Setup** menu.
2. Use the **down** ↓ arrow key to scroll to the **Sonde Frequency** selection.
3. Press **Enter** or use the **right** → arrow key to choose the sonde frequency.

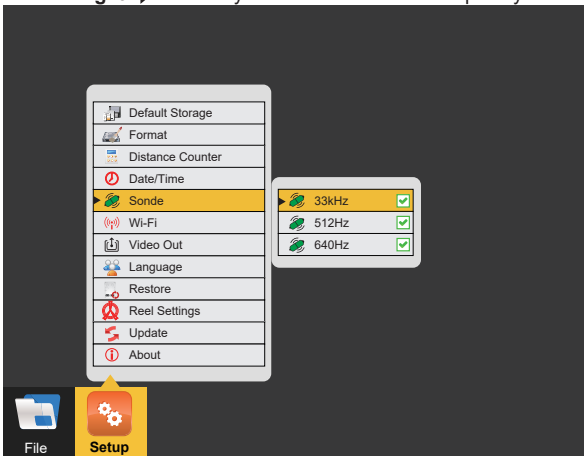

4. Use the **up** ↑ and **down** ↓ arrow keys to make your selection, and press the **Enter** key after each selection.
5. Press the **ESC** key to return to the main **Setup** menu, and press **ESC** twice to return to the main screen.



If the sonde frequency was changed in the setup menu while the sonde was active, the change would not take effect until you turn the sonde off and then on again.

3.2.7 Wi-Fi Administration

The Wi-Fi administration sets the SSID, IP address, and password for the control module's Wi-Fi. This area is locked for factory and authorized repair use only.

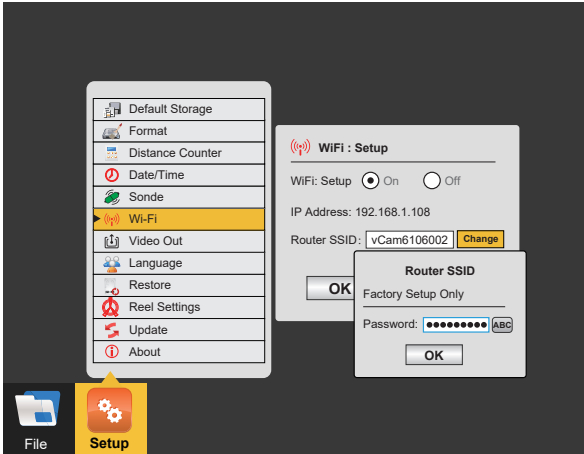

This can only be changed from this screen by an authorized service center or the factory.

3.2.8 Setting the Reel Type

This control module can be used with several types of Vivax-Metrotech pushrod reels. Selecting the correct reel-type helps the control module calculate the distance of the pushrod deployed into a pipe. Know beforehand which model of reel and length of pushrod will be used.

1. Press the **F10 Menu** twice to bring up the **Setup** menu.
2. Use the **down** ↓ arrow key to scroll to the **Reel Settings** selection.
3. Press **Enter** or use the **right** → arrow key to enter the reel choices sub-menu.
4. Use the **up** ↑ and **down** ↓ arrow keys to highlight the reel model type. Note that the Type-M and Type-CP reels offer a choice of pushrod length by pressing **Enter** again or using the **right** → arrow key.



5. Highlight the reel choice and sub-menu length choice if applicable.
6. Press the **Enter** key to save the changes.
7. Press the **ESC** key to return to the main **Setup** menu, and press **ESC** twice to return to the main screen.



The distance counter is for reference only. Before excavating, you must verify the actual position and depth with a Sonde Locator or Pipe & Cable Locator.

3.2.9 Restore the Factory Default Settings

Restoring the default settings will erase all the settings on the control module and return it to the factory default. This will not erase any videos or images on the hard drive.

1. Press the **F10 Menu** twice to bring up the **Setup** menu.
2. Use the **down** ↓ arrow key to scroll down to the **Restore** selection and press **Enter**.

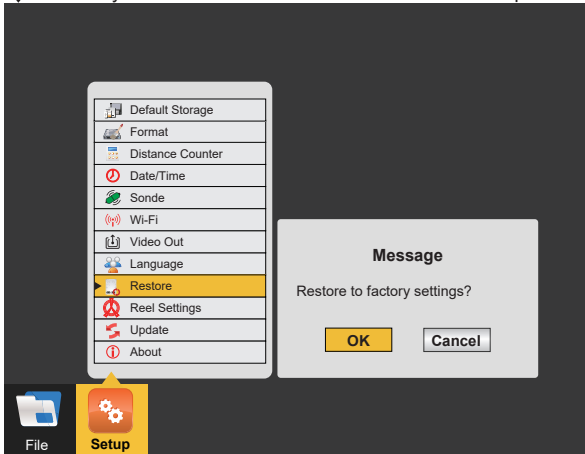

3. Use the **left** ← and **right** → arrow keys to select **OK** or **Cancel**.
4. Pressing **OK** will restore all settings to the default factory settings. **Cancel** will cancel the operation, and no changes will be made.

3.2.10 Update the Control Module Firmware

The firmware can be updated by the vCam Mobile Controller app or by downloading the update file and manually installing it via a USB thumb drive.



Please do not interrupt the update once it has started. Update the firmware with the control module while running under AC power.



Make a note the control module's current software version before running the update. You can compare the before and after versions when the update is completed.

3.2.10.1 Over-the-Air Updates

All vCam-6 control modules running firmware version DVR_033 or later can use the vCam Mobile Controller app to update the control modules firmware.

1. Launch the vCam Mobile Controller app and connect to the vCam-6.

2. If the vCam-6 firmware is outdated or a new update is available, a pop-up dialog box will appear advising so.

A new update is now available. Go to Settings -> Over The Air System Update to update the software OK

3. Select OK to proceed with the firmware update.

4. If OK is selected a progress bar indicator will appear during the update.

Firmware Update - Installing: 55 %

5. When the update is complete the the unit will reboot and return to the connection screen. The pop-up message will show a countdown to the reconnect screen.

Firmware Update

The Unit was successfully updated and it will be restarted. 48s auto reconnect.

6. After the unit has rebooted you are ready to reconnect to the reel and use it for your next inspection.

3.2.10.2 Manual Update by UBS Thumb Drive



Please do not interrupt the update once it has started. Update the firmware with the control module while running under AC power.



Make a note the control module's current software version before running the update. You can compare the before and after versions when the update is completed.



Check our YouTube Channel for an instructional video on manual firmware updates.

Firmware upgrades come in the form of “.bin” (for DVR updates) and “.soc” (for processor updates) extension files. It may be necessary to upgrade one or both. The order in which they are updated does not matter. The firmware files can be obtained from our website, an authorized service center, or the local Vivax-Metrotech office. USB thumb drives or SD cards can be used to perform the update.

The firmware update files must be installed on the **SD or USB device's “root directory.”** Specifically, the files must be visible when viewing the contents of the SD or USB device. The files **cannot be compressed or in a folder.**



Please do not interrupt the update once it has started. Update the firmware with the control module while running under AC power.



Note the control module's current software version before running the update. You can compare the before and after versions when the update is completed.

Wait, the control module will reboot after the firmware installation is complete. Leave the control module alone until it reboots. Some time may lapse between the progress indicator disappearing and the re-boot.

1. Extract the firmware update files and copy the .bin or .soc files to an SD or USB device. **The files must be on the drive's root drive or card, i.e., the files must not be compressed or in a folder on the device.**
2. Plug the SD or USB device into the control module.
3. Press the **F10 Menu** key twice to bring up the **Setup** menu.
4. Use the **down** ↓ arrow key to scroll down to the **Update** sub-menu. Press the **Enter** key.

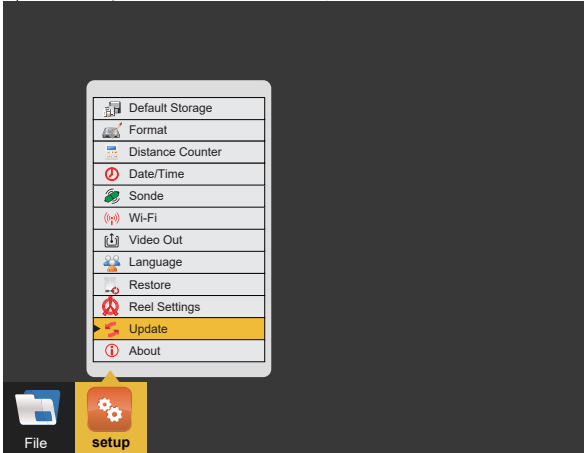

5. Use the **up** ↑ and **down** ↓ arrow keys to highlight and select **Update Firmware** and press Enter.

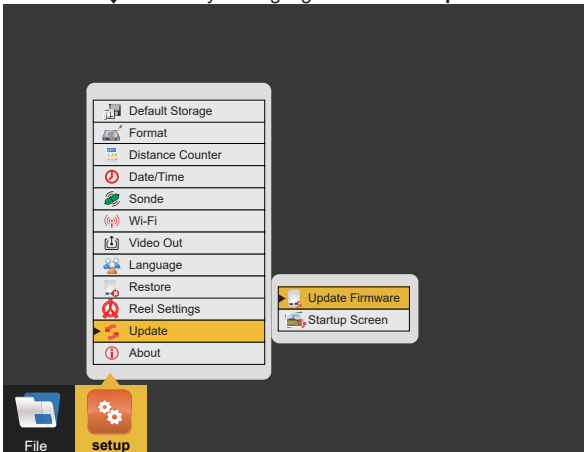

6. Use the **up** ↑ and **down** ↓ arrow keys to select the SD or USB device with the firmware loaded onto it. Press the **Enter** key.

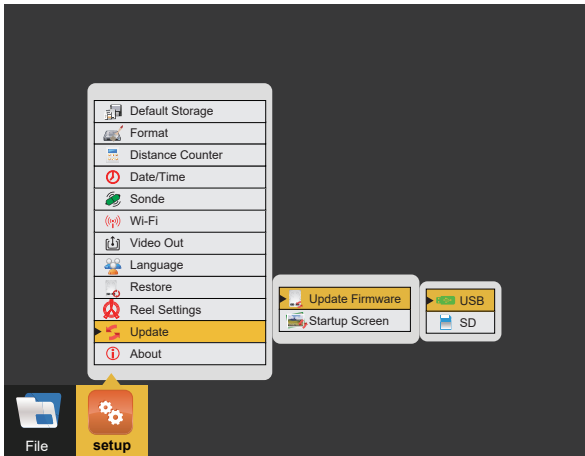

7. Use the **up** ↑ and **down** ↓ arrow keys to select which file type is used for the update: .bin or .Soc and press the **Enter** key.

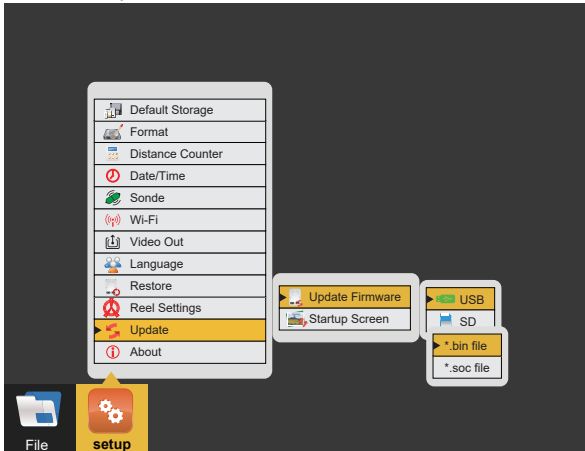

8. Use the **up** ↑ and **down** ↓ arrow keys to highlight and select the .bin or .soc file and press **Enter** key.

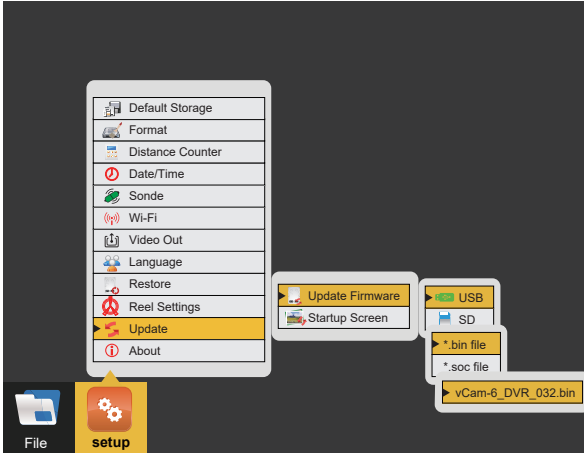

9. The **FIRMWARE UPDATE** progress bar will appear. Let the update run until finished.



10. The control module will reboot. The firmware update is now complete. Verify that the firmware update was successful by checking the firmware version in the **About** section of the setup menu.

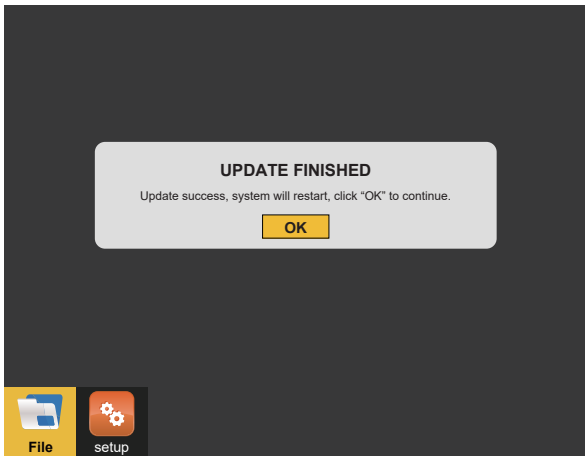

3.2.11 Update the Control Module Start Screen

This option allows the personalization of the second start screen seen when the control module is starting. A company name, logo, and phone number is an example of how to customize this screen. Any image, text, or logo can be used as long as it is in a JPEG image format.

To use a picture, it must be:

- JPEG format
- 700 x 480 pixels
- 24-bit or 32-bit color depth
- 96 dpi

If larger or smaller images are used, the picture on the screen may be distorted.

1. Load the jpeg format image file onto an SD or USB device.
2. Insert the device containing the jpeg image into the control module's SD or USB port.
3. Follow steps 1 through 5 in section 3.2.10. Update the Control Module Firmware on how to update the firmware. Use the **right** ➡ arrow key to highlight and select the **Startup Screen** selection and press the **Enter** key.
4. Use the **up** ⬆ and **down** ⬇ arrow keys to select the USB or SD device from the sub-menu, which has the image file loaded onto it. Press the **Enter** key.

3.2.12 The About Screen

The about screen shows the control module's current "firmware" (software) version, the firmware release date, and the current video format (NTSC or PAL and SD or HD) being used. The two types of firmware are (1) the DVR and (2) the MCU.

You will be asked for the firmware version if calling for technical support.

1. Press the **F10 Menu** twice to bring up the **Setup** menu.
2. Use the **down** ⬇ arrow key to scroll down to the **About** selection.
3. Press **Enter**, and the firmware version information will be displayed.

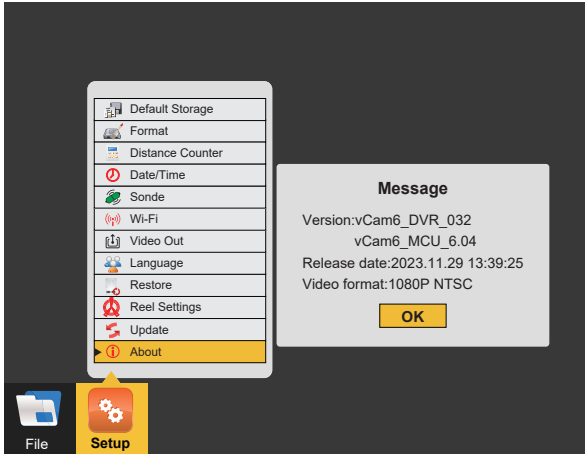

4. Use the **left** ← arrow or **ESC** keys to return to the **Setup** menu.

3.2.13 Video Out

Changing the video out setup may be needed when using the video out socket with certain LACP Observation Software. Check with the software manufacturer if this setup option is required.

1. Press the **F10 Menu** twice to bring up the **Setup** menu.
2. Use the **down** ↓ arrow key to scroll down to the **Video Out** selection.
3. Press **Enter**, and the choices of **Camera** and **CVBS** are shown.

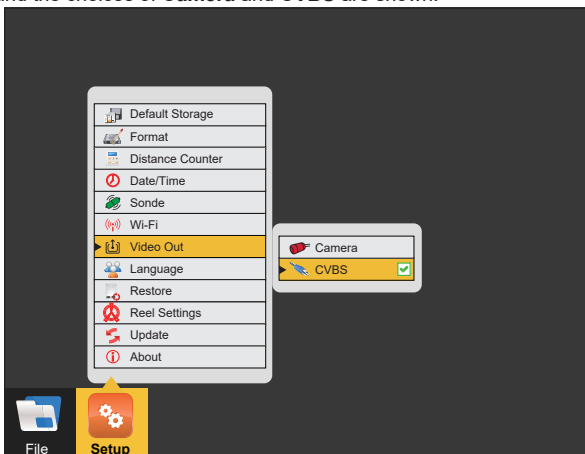

4. Use the **up** ↑ and **down** ↓ arrow keys to make the selection. Press the **Enter** key.
5. Use the **left** ← arrow or **ESC** keys to return to the **Setup** menu.

4. Video Recording and Picture Image Capture

4.1 Overview

This section of the manual covers video recording, capturing images, reviewing videos and pictures, and copying, moving and deleting video and picture files. To accomplish these items, we must understand the menu system, file system, and navigation in them.

4.2 Main File Menu

The vCam-6 control module uses a cascading menu system that primarily uses the **left** ←, **right** →, **up** ↑, **down** ↓ arrow keys, **Enter**, and **ESC** keys to move through the menus and sub-menus. A yellow bar will always highlight the current position and selection. A wireless mouse can also be used to move around the menus. Although this may not be a practical feature in the field, it may be helpful when working in the office.

The menu system consists of:

- Main File menu
- File List sub-menu
- File Option sub-menu
- Media Select sub-menu



Use the **F10 Menu** key to bring up the main **File** menu.

The main **File** menu contains four parts. From top to bottom, they are:

- All Files** – The **All Files** section of the main menu will show both picture files and video files on the hard drive or other storage. Use the **right** → arrow key to advance to the next sub-menu (file list sub-menu) to see the list of pictures and videos stored on the control module's hard drive, SD, or USB device.
- Video** – The **Video** section of the main menu will show only video files on the hard drive or other storage. Use the **right** → arrow key to advance to the next sub-menu (file list sub-menu) to see the video recordings stored on the control module's hard drive, USB drive, or SD card.
- Picture** – The **Picture** section of the main menu will show only picture files on the hard drive or other storage. Use the **right** → arrow key to advance to the next sub-menu (file list sub-menu) to see the list of pictures stored on the control module's hard drive, SD, or USB device.
- Other Storage** - Allows viewing videos and pictures on an SD or USB device currently plugged into the control module. In the other storage view, the total size and amount of free space of the SD or USB device can be seen.

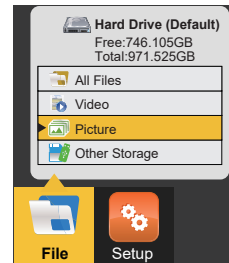

To view the contents of a USB thumb drive or SD card:

- Insert a USB thumb drive or SD card into the control module.
- Use the **down** ↓ arrow key to select and highlight **Other Storage**.
- Use the **right** → arrow key to advance to the next sub-menu (file list sub-menu) to see the JPEG images stored on the control module's SD or USB device currently plugged into the control module.



Only videos or pictures created in the control module will appear in the file list sub-menu and be viewed on the control module.

4.2.1 File List Sub-Menu

The file list sub-menu shows the hard drive's files, videos, or pictures. Contents of an SD or USB device can also be viewed if they are currently plugged into the control module. In the video file list sub-menu, pausing on a video file will start a preview window. The file preview dialog box will also show the length of the video and its size in MB.

File Select Sub-Menu

- 1. Next page scroll direction** – Scroll to the next page of files by using the Page Down key.
- 2. Page number** – Indicator of which page number and the total number of pages.
- 3. Filename** – Filename consists of YY MM DD HH MM. When multiple pictures are taken within one minute, an alpha character will be added to the end of the file name.
- 4. Selection checkbox** – Pressing the Enter key while on a highlighted file will add a green checkmark. Use this to select multiple files.
- 5. Previous scroll direction** – Scroll to the previous page of files by using the Page Up key.
- 6. Picture/video icon** – This icon describes a video or picture file while viewing all files.

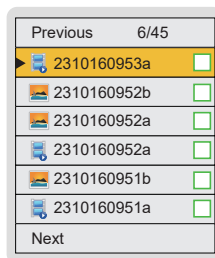

Use the right arrow key from the main File menu to move to the file list sub-menu.

The **up** ↑ and **down** ↓ arrow keys move through the list of video or picture files in the file list sub-menu. The currently selected file is always highlighted in yellow and will have a green outlined checkmark to the right. Pressing the **Enter** key while on a highlighted file will add a green checkmark to the right of the file name. Multiple files can be selected by moving from file to file with the **up** ↑ and **down** ↓ arrow keys and pressing **Enter** on each file to be selected.

Moving from page to page – The file list sub-menu may contain multiple pages, with six files per page. The top right section of the sub-menu shows the current page and the total number of pages. For example, if “2/14” shows, page two is the current page out of 14.

Method one – Use the **Page Up** and **Page Down** keys to move between pages.

Method two – Use the **up** ↑ / **down** ↓ arrow keys to highlight the bottom row **Next** or the top row **Previous**. After the **Next** or **Previous** row is highlighted, use the **left** ← or **right** → arrow keys to move a page forward or backward at a time.

Selecting multiple files:

Each file in the file list sub-menu has a green outlined box to the right of the file. Highlight a file in the list and press the **Enter** key. Now the box to the right will show a green check symbol. Repeat these steps for each file you wish to select. Multiple files can be copied across several pages.



Use the TAB key while in the File Select sub-menu to select the entire page of videos or pictures.



In the video file list sub-menu, momentarily pausing on a file in the list will start a preview window. The file preview dialog box will also show the length of the video and its size in MB. Using the Text Writer during the start of the video recording will allow you to identify your target video easily. The text on the recorded video will also be seen during the preview.



The video preview should take four to five seconds to appear and start playing. The fewer videos you have on the hard drive, the faster the preview will begin. The preview will take longer to pop up and play when the hard drive fills with videos and pictures.

4.2.2 File Option Sub-Menu

The **File Option** sub-menu shows the options available for files selected in the previous file list sub-menu.

The **File Options** sub-menu consist of:

1. **Play Video or View Picture** – The **Play** option will start playing the recorded video or view an image file. Pressing the **ESC** key twice will stop the playing video, close the image view, and return to the previous sub-menu.
2. **Copy Video or Picture** – The **Copy** option will make a copy of the selected video(s) or picture(s) and copy it to a USB drive or SD card. The Copy option makes a copy of the video or picture and leaves the original on the default storage drive.
3. **Move Video or Picture** – The **Move** option will remove the selected original video(s) or picture(s) from the default drive and move it to the USB drive or SD card. No copy of the file will remain on the default drive.
4. **Delete Video or Picture** – Delete will delete the selected video(s) or pictures(s) from the default drive. No copy is retained, and a file cannot be recovered after it is deleted.
5. **Rename Video or Picture** – The **Rename** option allows re-naming files on the control module's hard drive. When selected, up-to 20 alpha-numeric characters can be used to rename the file.

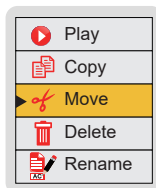

Files moved off the control module hard drive cannot be placed back on the control module. Files deleted from the control module cannot be recovered.

4.2.3 Media Select Sub-Menu

The **Media Select** sub-menu will show the available media (SD or USB device) available (plugged in) and select the file's destination being copied or moved.

Media Select sub-menu options.

1. **USB** – Selecting USB will move the selected video(s) or picture(s) to the USB thumb drive plugged into the control module.
2. **SD** – Selecting SD will move the selected video(s) or picture(s) to the SD card plugged into the control module.

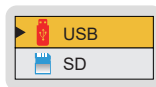

F10 Menu key

Press once to bring up the **main file menu**, which is the day-to-day menu used most often, and press again to bring up the setup menu to make changes to the control module options.







Left and Right arrow keys

The **Left** and **Right** arrow keys move through the file sub-menus.



Up and Down arrow keys

The **Up** and **Down** arrow keys scroll the list of video and picture files in the file list sub-menu, the choices in the file option sub-menu, and the options in the media select sub-menu.

	Enter	Pressing the Enter while in the:
	File List sub-menu	Select the file by adding the green checkbox to the far right.
	File Option sub-menu	Will start the action of playing, copying, moving, or deleting.
	Media Select sub-menu	The file will be moved to the SD or USB drive.
	Page Up and Page Down	The Page Up and Down keys will scroll one complete page at a time through the file list sub-menu.
	Tab	Use the Tab key in the file to select the sub-menu to select the entire page of videos or pictures.
	ESC	Use the ESC key in any menu or sub-menu to step back. Press the ESC key repeatedly to return to the main viewing screen. Pressing the ESC key in a file copy or movement will stop that operation.
	F1 Help	The F1 Help key will give a brief overview of the options and commands of the control module.

4.3 Video Recording and Playback Controls

Video recordings will be saved to the default drive selected in the initial control module setup. All videos and pictures will be saved to the internal hard drive by default. If recording directly to an SD or USB device, insert the device and make sure the default drive is set to either the SD or USB device.



Leave the hard drive as the default drive. The hard drive's contents can be copied to USB drives or SD cards while retaining the original videos and pictures.



Keep as much free space on the hard drive as possible. The menu system will work more efficiently with fewer files on it. Keeping the hard drive free also limits loss in the case of a catastrophic event.

Recording, Picture Capture, Playback, and Zoom Controls (top panel)

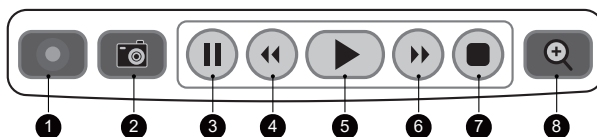

- 1 **Start Recording** Use this key to start a recording. A red flashing recording icon will appear on the bottom-left section of the status bar on the screen, and the elapsed recording time will appear in the bottom center.
- 2 **Picture Capture** Use this key to take a jpeg picture from live video, the current recording session, or video playback. The picture icon will momentarily appear on the status bar, confirming that a picture was taken.

- 3 **Pause Recording** Press the **Pause** key to pause the recording video. While the video is paused, the pause icon will appear on the bottom-left section of the status bar on the screen, and the elapsed recording time will pause. To resume recording, press the **Pause** key again, and the recording icon will replace the pause icon.



When a recording is paused, the system clock keeps running. When playing back the video, you will see a jump forward in the time shown on the video. (If the clock was showing while the video was recording).

- 4 **Rewind Video Playback** Use this key to rewind the currently playing video. Press up to three times again to increase the rewind speed.
- 5 **Play Video** Use this key to play a video from the File Select list or to resume playing a paused video.
- 6 **Forward Video Playback** Use this key to forward through the currently playing video. Press up to three times again to increase the forward speed.
- 7 **Stop Recording** Use this key to end a video recording session. The recording will stop and be saved to the default drive. Also, use this key to stop a video being played in the control module.
- 8 **Digital Zoom** Use this key to zoom in on live, recorded, or jpeg captures. Press once to bring up the red zoom box on the screen. Move the zoom box to the area to be magnified in on and press the **Enter** key. At the same time, the zoom box is shown press up to three times more to increase the digital zoom level.

4.3.1 Making a Video Recording

Videos will be saved to the default drive you selected in the initial control module setup. The videos will be saved on the internal hard drive if no other drive is selected.

1. Press the **Record**  icon on the top panel keypad.
2. The recording icon will appear on the status bar on the screen. When the record icon starts flashing, the recording begins. In the center of the status bar, the elapsed recording time will be displayed in hours, minutes, and seconds.
3. The video will continue to record until it is stopped by pressing the **Record** key again or using the **Stop** key.

During a video recording, the following options are operational and usable:

- Wi-Fi
- Sonde
- Microphones
- Full-Text writer
- Camera LED control
- Distance counter reset
- F9 Display adjustments
- Take a JPEG image picture
- Pause the video for up to 30 minutes
- Use the digital zoom to view close-up (view only; the zoom effect will not be recorded)
- Pushrod tracing (some interference may occur on the LCD)

4.3.2 JPEG Image Picture Capture

Pictures will be saved to the default drive you selected in the initial control module setup screen. The pictures will be saved on the internal hard drive if no other drive is selected.







1. Press the **Picture Capture**  key on the top panel keypad.
2. The picture icon and file name will appear momentarily on the bottom left of the status bar, confirming that the picture was taken and saved.
3. Pictures can be taken from live video while a recording is in progress or from a video played back in the control module.



Use the Text Writer feature to add identifying text to the recording video and image captures. Now, while looking at the preview in the file list sub-menu, the text recorded on the video and pictures will help identify the target video or picture.

4.4 Play Videos and View Pictures in the Control Module

To Play Video Files:

1. Press the **F10 Menu** key to bring up the main File menu.
2. Use the **right**  arrow key to move to the file list sub-menu.
3. Use the **up**  and **down**  arrow keys to scroll and highlight the video or picture to be viewed. When the file is highlighted, after a few seconds of a video preview, its length and size will pop up.
4. Press the **Enter** key to select and check the file.
5. Use the **right**  arrow key to move to the File Option sub-menu.
6. Use the **right**  arrow key or press the **Enter**  key to play the video.



7. Press the **ESC** key twice to return to the file list sub-menu or the **Stop /** key on the top keypad to stop the video playback.
8. During video playback, the following options are operational and usable:
 - Wi-Fi
 - Rewind and fast-forward
 - Take a JPEG image picture
 - Pause the video for up to 30 minutes
 - Use the digital zoom to view close-up (view only)

4.4.1 View Picture Image Files:

1. Use the steps in section 4.4 to play videos and view pictures in the control module.
2. Only this time are you using picture images rather than video files.

4.4.2 Renaming a Video or JPEG Image File

Video and picture files on the control module can be re-named from the default date format. Filenames can be up to 20 alphanumeric characters. !@#\$\$%^&*() and . are characters that cannot be used to rename a file. After the file is renamed, the file's location is still at the same location in the file list as originally placed by the default date format file name.

1. Press the **F10 Menu** key to bring up the main File menu.
2. Use the **right** \rightarrow arrow key to move to the file list sub-menu.
3. Use the **up** \uparrow and **down** \downarrow arrow keys to scroll and highlight the video or picture to be viewed. When the file is highlighted, after a few seconds of a video preview, its length and size will pop up.
4. Press the **Enter** key to select and check the file.
5. Use the **right** \rightarrow arrow key to move to the File Option sub-menu.
6. Use the **down** \downarrow arrow key to highlight the **Rename** option and press **Enter**.

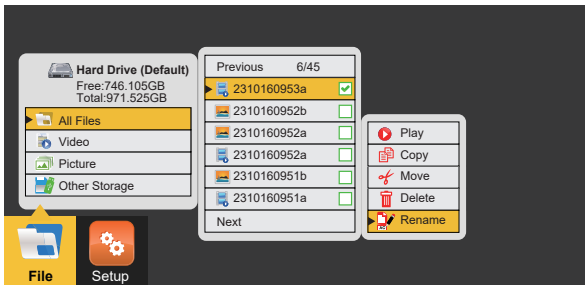

7. The file rename dialog box now appears. Enter up to 20 characters to rename the file, press the **right** \rightarrow arrow key to bring up the **OK** confirmation box, and press **Enter**.

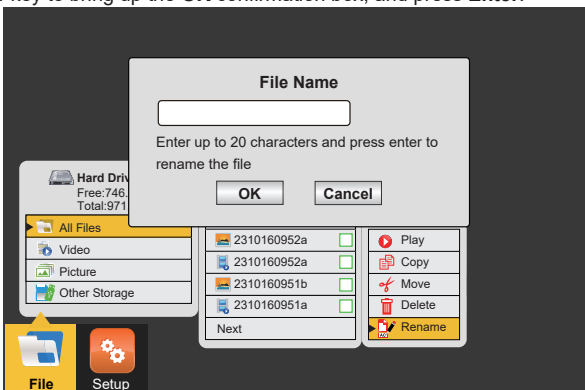



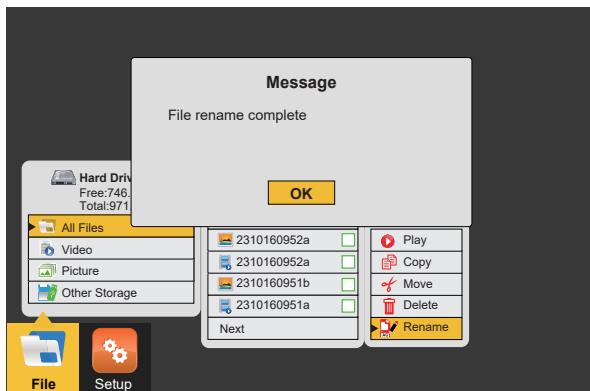





8. The file rename confirmation message will appear and disappear after four seconds.



9. The file rename is now complete.

4.4.3 Copy, Move or Delete Videos and Pictures

In the File Option, sub-menu files can be copied or moved to an SD or USB device or deleted from the hard drive.

1. Plug an SD or USB device into the appropriate slot in the control module to copy or move files. Ensure there is enough space on the SD or USB device being used.
2. Press the **F10 Menu** key to bring up the main **File** menu. Use the **up**  or **down**  arrow keys to scroll to and highlight **Video**, **Pictures**, or **All Files**.
3. Press **Enter** or use the **right**  arrow key to move to the file list sub-menu.
4. Use the **up**  or **down**  arrow keys to highlight and select by pressing the Enter key, which is the file to move, copy, or delete. Pressing the **Enter** key will place a green checkmark to the right of the file name.
5. Use the **right**  arrow key to move to the file option sub-menu.
6. In the file option sub-menu, use the **up**  or **down**  arrow keys to select **Copy**, **Move** or **Delete**.
7. If copying or moving files, select copy or move and use the **right**  arrow key to move to the Media Select sub-menu. Select the destination for the file (SD or USB device) and press the **Enter** key to complete the action.

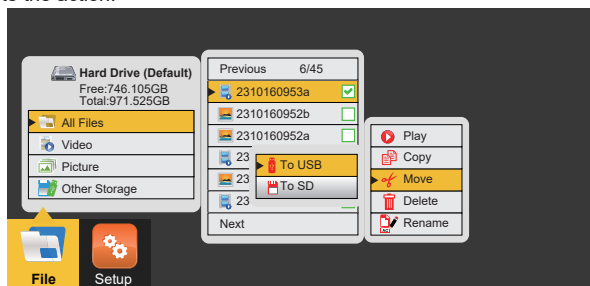

8. A confirming message will appear. Select **OK** to continue.

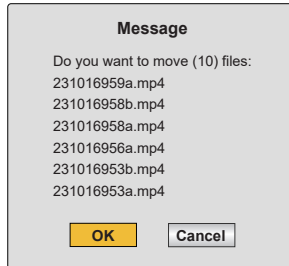

9. During the copy or move process, a progress indicator bar will appear in the top center of the screen. This will show:

- The specific file out of the total number of files being processed
- The total number of files to be processed
- The size in MB already processed
- The total size of all selected files
- Cancel option

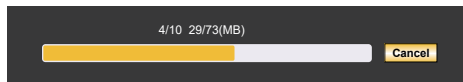

10. If deleting files, use the **down** ↓ arrow key to select **Delete** and press **Enter**.



Do not remove the SD or USB device from the control module while copying or moving files to them. This may result in creating corrupt, unplayable files and the risk of corrupting the original file on the hard drive.

4.5 File Format of SD Cards and USB Devices

The vCam-5 and vCam-6 control modules will recognize USB thumb drives and SD cards formatted in the FAT32 or NTFS file system and a maximum size of 64GB for SD cards and 128GB for USB thumb drives. If other file formats are used, the control module will show an error message of "Not enough space on disk" when copying or moving a file to it. The control module cannot read media in other formats, but it knows that a USB or SD card is plugged in, so it perceives the SD or USB device as full.

In the Windows operating system, having more than one type of disk drive is possible and common. The most common is "Local" and "Removable" drives. SD and USB devices are in the "Removable" disk class. It is possible to convert an SD or USB device into a "bootable" drive and use it to run programs. When an SD or USB device is converted to a bootable disk, it is now classified as a "Local" disk. The control module will work with the removable disk but **not a local one**.

To check if your SD or USB device is a local disk or a removable disk, plug it into any computer running any Windows version. Launch "My Computer" to see a screen similar to the illustration below. The illustration below shows the drives lettered C, E, and G as a local disk. These will not work in the control module. The second line shows drive "H" as a removable disk, which will work in the control module. If a disk is converted into a bootable disk, it is impossible to convert it back to a format that will work in the control module.

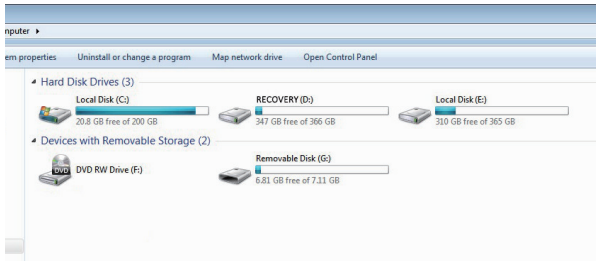

4.6 Video Format

The vCam-6 control modules use the MP4 video format. MP4 files were created under the ISO/IEC 14496-12:2001 standard by the ISO/IEC and Motion Picture Experts Group (MPEG). Because of this, MP4 is an international standard for audio-visual coding.

4.7 Troubleshooting Video Playback

If a video file can be played in the vCam control module, it can be played on a laptop or PC. If files cannot be played in the control module, the video file may have become corrupt.

When files can be played in the control module but not on a PC, the following should be checked in this order.

Default App and File Associations – this tells the PC's operating which software program it should use to play the .mp4 files from the control module. File associations must be set only once and will stay set until manually changed or sometimes when a major windows update is run. Consult the Help section of your windows operating system for directions for setting the default app and file associations.

Codecs – the video and audio tracks in a file have been "encoded" or "coded" and must be "decoded" in the right way to play the file back. Therefore, a codec is needed (Coder / Decoder). A media player, such as WMP (Windows Media Player), may require a specific codec to be installed to play a specific type of video file. Consult the Help section of your video player program for information on downloading codecs.

Corrupt Video Files – some situations and circumstances may cause a .mp4 video file to become corrupt. Third-party software may be able to help with this situation.

4.8 Corrupt Video Files

A file typically becomes corrupted when a problem occurs during the recording session, saving the file, or copying or moving the video file. If your control module loses power or crashes as you copy or move a file, there's a good possibility that the file will become corrupted.

Other possible causes of corrupt video files are:

- The USB or SD card was removed from the control module before the copy or move function could be completed.
- The control module loses power when the file is recorded, copied, or moved.
- The control module is dropped or moved, and the USB drives lose connection with the USB port as the file is recorded, copied, or moved.
- Using inferior quality USB drives or SD cards.

If a file is copied or moved from the control module and will not play on a PC:

- Check to see if the file will play in the control module. The file may have been corrupted during the move or copy if it does not play. Try to recopy the file again, ensuring it does not interrupt the process until it is finished.

If a file is copied or moved from the control module, it will play in the control module but not play on a PC:

- Try a different media player on the PC and try a different PC. The MP4 video format used by the control module is a Microsoft format and should play in the Windows Media Player with no issues. If the file is not playing or playing incorrectly, there is a possibility that the correct video codec is missing. Computers running Windows 8 or higher will likely have this codec installed by default. It is possible that in older operating systems, a codec may need to be installed. See section 4.7 Getting Codec.

5. Features Available During Recording

During a video recording, the following options are operational and usable:

- Wi-Fi (see section 6, Wi-Fi)
- Sonde (see section 10, Locating Sondes and Pushrod)
- Audio Commenting (see section 5.1, Voice Over)
- Full-Text writer (see section 5.7, Text Writer)
- Camera LED control
- Distance counter reset
- F9 Display adjustments
- Take a JPEG image picture (section 4.3.2, JPEG Image Capture)
- Pause the video for up to 30 minutes (section 4.4, Play Video and View Pictures in the Control Module)
- Use the digital zoom to view close-up (view only; the zoom effect will not be recorded)
- Pushrod tracing (section 10, Locating Sondes and Pushrod)

5.1 Voice Over

The voice-over feature will add audio comments to the recorded video. The control module has an internal microphone located to the left of the microphone on/off button. An external microphone jack is located below the microphone on/off button. Use an external microphone when in a noisy area.



Microphone on/off button



When the microphone is on, this icon will show on the status bar



Internal microphone



External microphone jack

1. Press the **Microphone** button on the front panel of the control module. The button will glow red when the microphone is on, and the microphone icon will be shown on the screen's status bar.
2. Speak clearly at a normal tone and volume towards the internal microphone labeled with an icon to the left of the microphone on/off button.
3. Stay between one and two feet from the internal microphone while speaking.
4. Press the **Microphone** button again to turn the microphone off.

5.2 Volume Control

During playback of the recorded video, the volume level can be adjusted.

Press and hold the **Ctrl** key, then use the **-** (dash) and **+** (plus) keys to lower and raise the playback volume. The volume status will appear at the bottom center of the screen while the changes are being made.

Press and hold the **Ctrl** key, then use **-** (dash) and **+** (plus) to lower and raise the playback volume.

Ctrl and **+** to raise playback volume

Ctrl and **-** to lower playback volume



5.3 Display and Backlight Settings

At any time, pressing the F9 Display key will bring up the color settings/backlight sub-menu. From this menu, the color settings for the LCD can be made, the touchscreen function can be turned on or off, and the backlight can be turned on or off.

1. Use the **up** ↑ and **down** ↓ arrow keys to move between the color settings selections.
2. Use the **left** ← and **right** → arrow keys to lower or raise the display settings.
3. Use the **left** ← and **right** → arrow keys to turn the backlight on or off. (Left is off, and right is on.)
4. Press the **Enter** key to save the new display setting and exit the sub-menu.

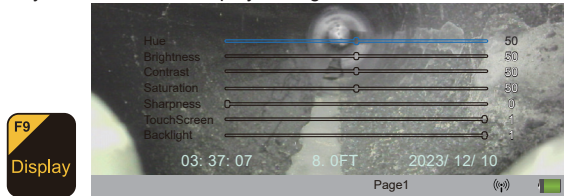

5.4 On-Screen Status Bar

The status bar shows the battery status and active features such as sonde, microphone, and Wi-Fi. The key combination of **Ctrl + F10** will hide the status bar. Use the same key combination to bring the status bar back.

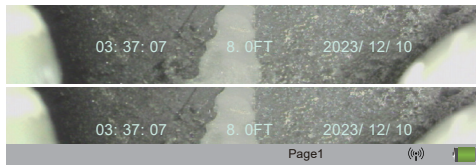

5.5 On-Screen Display (OSD Info)

The current time, date, and distance of the pushrod deployed will be shown on the screen and recorded in videos and pictures. The color of the OSD info can also be changed to suit the environment inside the pipe being inspected. By default, the OSD is positioned at the bottom of the screen and in white text.

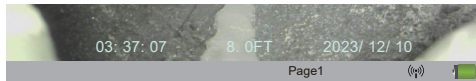

1. Press the **F2 Info** key once to show the OSD at the bottom of the screen.
2. Press the **F2 Info** key again to move the OSD to the top of the screen.
3. Press the **F2 Info** key to turn it off and remove it from the screen.
4. To change the color of the OSD, press and hold the **Ctrl** key while pressing the **F2 Info** key to toggle through the available colors.

5.6 Camera LED Light Control

Use the camera **LED Dimmer** knob on the front panel to raise, lower, or turn off the camera's LED lighting.



5.7 Text Writer

5.7.1 Introduction to the Text Writer

The Text Writer function allows users to add descriptive text and comments to recorded videos and pictures. The user can customize the text description on the videos and pictures. The Text Writer has 20 pages with 14 lines and 30 characters per line per page to be saved and later recalled for use. The content from the Text Writer is saved into memory, so if the unit is turned off, the text will still be available when turned on again.



If the unit is reset to factory defaults, the saved pages of text will be lost. If the CMOS battery on the DVR circuit board is removed, all text will be lost. Only the text is saved in memory. Any colored text will be reset to the default white color.

The ESC, F3, F4, F5, F6, F7, F8, and F11, Page Up, and Page Down keys are related to using the Text Writer feature and are covered in this manual section.

5.7.2 Keyboard Function Keys of the Text Writer



Fn Keys	Function	Description
	Clear text from the screen	At any time, press the ESC key to clear the Text Writer's text from the screen.
+	Change the OSD position, turn it off, and change colors.	F2 – Info (On Screen Display) – The On Screen Display shows the Date, Time, and Distance set in the control module. This information will appear in videos and pictures. Pressing this key: x 1 will turn on and display at the bottom of the screen, x 2 will move it to the top, and x 3 will turn it off. Ctrl + F2 – Change On-Screen Display text colors – While holding down the Ctrl key, press the F2 Info key repeatedly to toggle through the colors of white, black, yellow, and green.
+	Change Text Colors	F3 – Text Color – Use the F3 Text key to change the text color from the default color of white, black, yellow, and green. Ctrl + F3 – turn off/on Press and hold the Ctrl key and press F3 to turn the text writer on and off. When the Text Writer is on, the page number is shown on the bottom right of the screen. When turned off, the page number is not shown.
	Change Background Colors	F4 – Text Background – Use the F4 key to add a background color and toggle through the background colors of black, white, and grey.
	Recall a saved page	F5 – Recall Page – Use the F5 Recall key to retrieve a saved page of text from memory. Press the F5 Recall key, and a page number dialog box will appear in the bottom-left section of the screen. Use the up and down arrow keys to scroll to the desired page to recall. When the number for the desired page to recall is shown, press the enter key to complete the operation.



Saves the current page of text

F6 – Save Page – Use this key to save the Text Writer's text into memory. When text is placed on the screen via the Text Writer, the page that contains the text can be saved into memory and recalled for future use.



Delete saved pages

F7 Delete Page – Use this key to delete a saved page of text. Recall the page or use the **Page Up** and **Down** keys to scroll to this page. While on this page, press the **F7 Delete** key to complete the operation.



Deleted pages cannot be retrieved.



Delete all saved pages

F8 - Delete All Pages – Use this key to delete all saved pages of text. Press the **F8** key, and a message will appear to confirm the deletion of all the pages. Use the **left** and **right** arrow keys to select **OK** to continue or cancel the process.



Deleted pages cannot be retrieved



Change Fonts

F11 – Font – Use this key to change the font type of the Text Writer text. Press repeatedly to scroll through five font types.



Darker colors may work better in pipes with water running through them. The lights from the camera head may reflect in the water, and white or yellow text may become washed out. Use a darker color and switch from light to dark when needed.



Note that the page being recalled will be recalled into the current page displayed by the page number on the screen's bottom right. Pressing the ESC key will clear the recalled text, and recalling the page number shown on the screen will bring back that text.



Use the Pause key on the top keypad to pause the video recording. With the video paused, use the up and down arrow keys to scroll through the saved pages of text and stop at the desired page. With the desired text being shown, un-pause the video to continue recording. Press the ESC key to clear the text from the screen at any time during the recording.



Third-party observation software (PACP and LACP) can be used with the control module through the USB Data Port and Video Out composite socket.

5.7.3 Text Writer Components

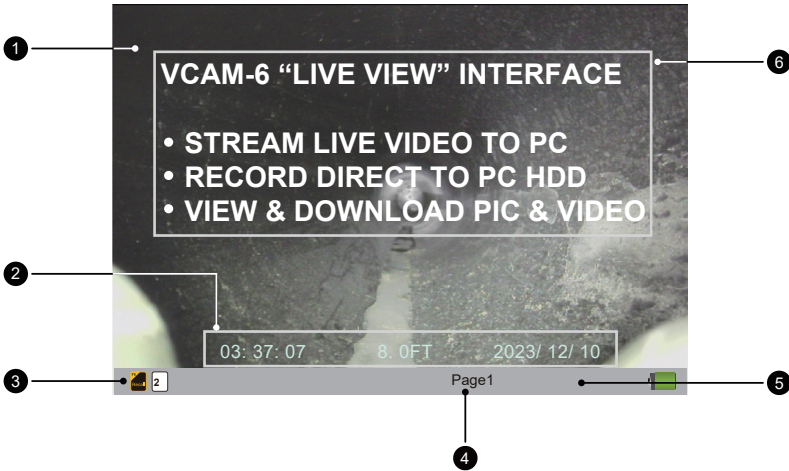

- 1 Main viewing area
- 2 Text Writer text
- 3 On-Screen Display of Time, Distance Deployed, and Date
- 4 Current Text Writer page
- 5 The Status Bar shows the battery status and active features such as a sonde, microphone, and Wi-Fi. The key combination of **Ctrl + F10** will hide the status bar. Use the same key combination to bring the status bar back.
- 6 Page recall dialog box will appear when the **F5 Recall** key is used to recall saved pages of text. Use the **up** and **down** arrow keys to scroll to the page number of the desired page to recall.



5.8 JPEG Image Capture

Pictures will be saved to the default drive you selected in the initial control module setup screen. The pictures will be saved on the internal hard drive if no other drive is selected.



1. Press the **Picture Capture**  key on the top panel keypad.
2. The picture icon and file name will appear momentarily on the bottom left of the status bar, confirming that the picture was taken and saved.
3. Pictures can be taken from live video while a recording is in progress or from a video played back in the control module.



Use the Text Writer feature to add identifying text to the recording video and image captures. Now, while looking at the preview in the file list sub-menu, the text recorded on the video and pictures will help identify the target video or picture.

5.9 Digital Zoom

Use the zoom feature while viewing live, recorded, or jpeg captures.

1. Press the **Zoom**  button on the top panel keypad to activate the zoom feature and bring up the red zoom control box on the screen.
2. Move the zoom box  with the arrow keys to the area to be magnified and press the **Enter** key.

Press up to three times more while the zoom box is shown to increase the digital zoom level. While using the zoom feature, no other keys on the keyboard, top panel, or front panel will be useable.

6. Wi-Fi

6.1 Wi-Fi Connection for App

The vCam-6 control module has built-in Wi-Fi that broadcasts an SSID (secure network name) and uses DHCP (the protocol that assigns an IP address needed to connect to the control module) to assign IP addresses to a tablet or smartphone running the VMC app.

When connected to the **VMC** app, the control module's video stream is transmitted. The video stream will include any text on the app's screen, and the on-screen display will show the system time, distance count, and date.



vCam-6 firmware version of "DVR_033 and above can use the VMC app to perform Over the Air firmware updates. When the vCam-6 control module is connected to the VMC app, the app can perform the firmware update.

Visit our website at www.vivax-metrotech.com for more information and download links.



The VMC app is available from the Apple App or Google Play sites.



Android



iOS



7. Using the Cable Reels



Do not use the control module as a handle to move the reel. Remove the control module or use the handle of the reel to move the reel.

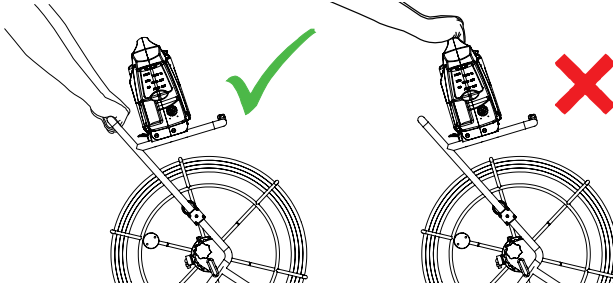

7.1 Cable Reel Overview

7.1.1 Mounting the Control Module

1. Line up the four pins on the control module bottom to the slots in the reel mounting blocks.
2. Lower the control module into the mounting blocks.
3. Push the control module backward until it is locked into place.
4. Unspool enough of the interconnect cable from the reel to allow its plug to reach the socket on the control module. Be aware of any excess cable around the cable cage that may become tangled when the cage starts spinning. Use the Velcro strap attached to the interconnect cable to secure the cable in place.

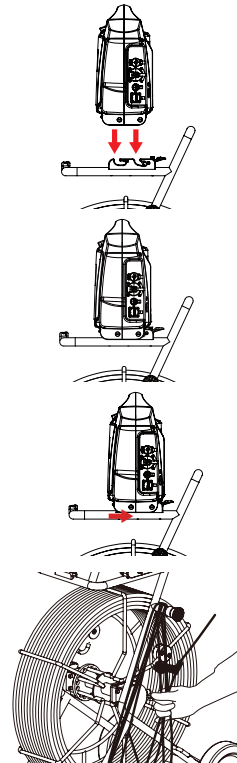

5. Plug the interconnect cable into the control module's bottom socket. This is a key plug and socket, so line up the red dot on the interconnect cable plug to the same red dot on the interconnect socket on the control module.

- a. Pull back the knurled ring on the plug.

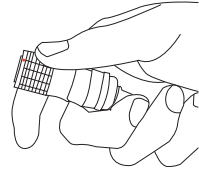

- b. Line up the red dot on the interconnect cable plug with the red dot on the control module's socket. Insert the plug into the socket and release the knurled ring.

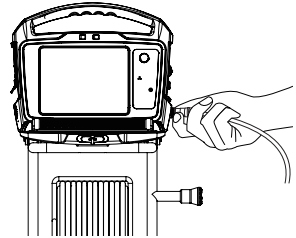

- c. Check that the connection is secure by giving a slight wiggle and tug.
d. To remove the interconnect cable, pull back the knurled ring and pull the plug out.



When securing the interconnect cable slack, do not leave the angle of the cable from the socket at a sharp bend. Leave some slack in the cable to prevent any broken internal wires where the cable meets the connector.

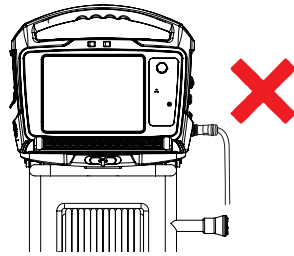
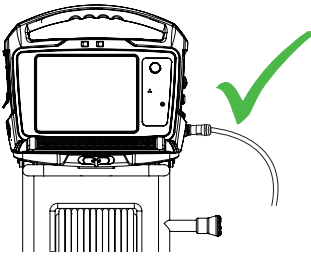

7.1.2 Remove the Control Module

Press and hold down the locking tab to release the locking mechanism. With the locking tab held down, use an upward and forward motion simultaneously to lift the control module out of the mounting brackets.

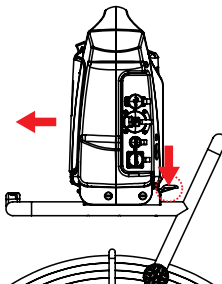

7.1.3 Pushrod Overview

The Pushrod Cable comprises a fiberglass rod surrounded by wire conductors and a Kevlar braid coated with a thick polypropylene jacket. Because of the harsh environment in which the pushrod is used, care should be taken to keep it in good operating condition.

Check Pushrod for Wear – Inspect the pushrod for cuts, kinks, and abrasions as it is retrieved back into the cable cage. If the jacket is cut or worn so the yellow or white Kevlar braid can be seen, it is time to replace the pushrod. Using the pushrod with open cuts will result in water and moisture entering the pushrod and eventually traveling through it, causing a degraded camera image or total image failure.

Keep the Pushrod and Termination Spring Assembly dry and clean – When retrieving the pushrod, keep a dry rag in one hand and wipe down the pushrod as it moves through it. Use low-pressure water to rinse off the camera head and rinse away accumulated dirt and debris that may be caught in the spring. Shake dry or use low-pressure air to blow the excess water away and dry the parts. The Camera Head, Pushrod and Termination Parts are exposed to harsh chemicals in day-to-day use, and keeping a clean system will help prolong the life of these parts.

Maintain proper control of the pushrod – Attempting to pull the pushrod out of the reel while the reel is locked will result in the pushrod collapsing and stressing the pushrod. Pushing the pushrod back into the reel while locked may cause the reel to tip over or kink the cable.

Rinse off the termination parts before the end of the day – The camera and pushrod are subjected to a very harsh environment with possibly very caustic chemicals. If the parts are not cleaned off and are allowed to dry dirty, the chemicals may wear these parts prematurely. Use low-pressure water to rinse out the termination spring parts. Wipe dry or use air to blow off the water before storing it for the night or long periods. Removing the skid when storing it is good to prevent water from drying between the skid and the camera head.

7.1.4 Distance Counter Accuracy

For best results from the distance counter, follow these instructions, starting with the control module being **turned off**. Also, check section 3.2.8 of this manual regarding “Setting the Reel Type” to ensure the correct reel type and footage of the reel are being used in the control module settings.

1. Turn the cage to approximately the 9 o'clock position using the sonde cup as the guide.

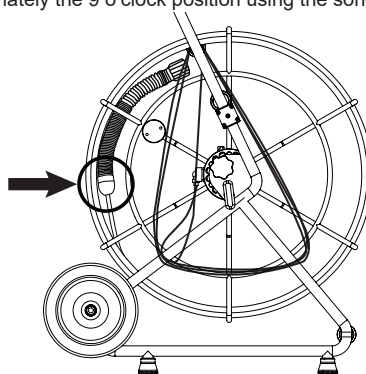

Sonde cup at 9 O'clock position

2. Hold the cage at 9 O'clock, grab the spring assembly, and thread the pushrod through the cable guide.

- Position the base of the sonde cup into the cable guide and lock the cage, as shown below. The sonde cup (a) is now in the cable guide at a 12 O'clock, and the pushrod section from the cage to the sonde cup (b) is bent from the cage to the cable guide.

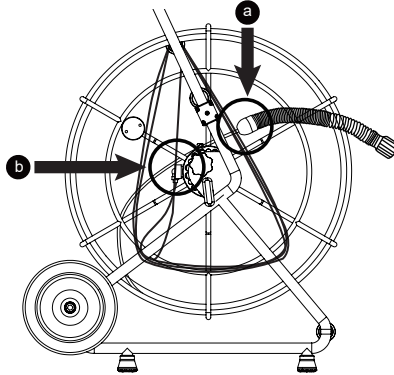

The sonde cup (a) in the cable guide at the 12 O'clock position

- Attach the interconnect cable to the control module.
- Power on the control module.

When the control module starts, it will see the position of the sonde cup as “zero.” Also, check section 3.2.8 of this manual regarding “Setting the Reel Type.”

7.1.5 Deployment of the Pushrod Cable



The friction brake should always be partially applied to slow cable deployment. To avoid injury, great care should be taken to stop the cable from unwinding.

Do not wear loose clothing that can become caught in a spinning reel. Keep hands away from a spinning reel.

- Position the reel on a flat surface approximately three to six feet or one to two meters from the entry point. This will provide enough space to work with the pushrod without much slack dragging on the ground. Use the friction brake to slow down the movement of the cable cage if needed. Using the reel in a horizontal position increases the width between the feet. This will give the reel more stability on uneven surfaces and lower the height when in confined spaces.
- Unlock the cable cage and loosen the friction brake so that the cable cage can spin.

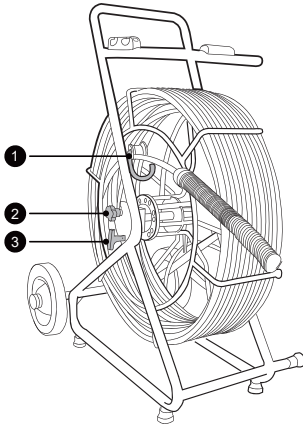

Type-CP Standard Reel

- 1 Cable Guide
- 2 Locking Brake
- 3 Friction Brake

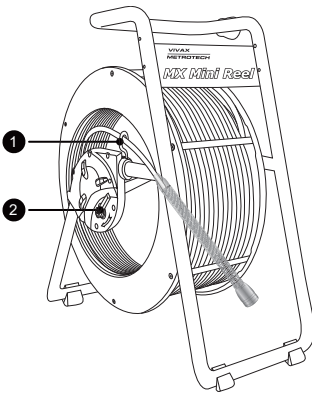

Type-MX Mini Reel

- 1 Cable Guide
- 2 Locking Brake and Friction Brake

3. Turn the cable cage forward (clockwise) until the camera head is approximately at 9 o'clock position.
4. Pull the termination spring out of the cage and enough of the pushrod through the cage opening to thread the pushrod into the cable guide.
5. The reel is now ready to be deployed into the pipe.

Before deploying the pushrod, you should:



- a) Remove standing water from the pipe before inspecting. Inspection cameras are used to inspect pipes, and the images will be much better if the camera head is not underwater.
- b) Remove debris and objects from the pipe first. The camera is made to inspect the insides of pipes and not to clean or unblock them.

Use the Insertion Sleeve as much as possible to prevent the pushrod from rubbing on sharp surfaces. Use devices such as a Tiger Tail when the point of entry makes it impossible to use the Insertion Sleeve, such as inspecting lines in a maintenance hole.



Insert Sleeve

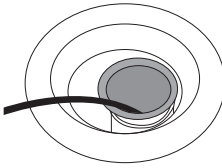

Insert Sleeve in the cleanout

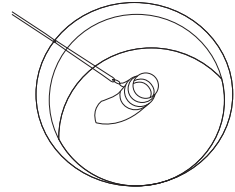

Tiger tail used on a maintenance hole

Use "grip" type rubber gloves to better grip and protect your hands from sludge during retrieval. The gripping action of the gloves will help keep a good hold on the pushrod while deploying.

Apply the push force to the pushrod as close to the entry point. Excess pushrod between the point of entry and while pushing could kick the pushrod. Never stand and use your weight to push on the pushrod. This may cause the pushrod to kink.

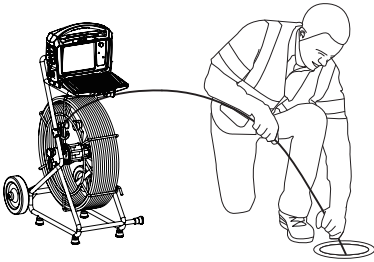

Proper placement and pushing force



Improper placement and pushing may result in kinking the pushrod

Use finesse and not force when needed. The camera and pushrod are made to travel through multiple bends within reason. If you are having trouble navigating through the pipe, try to pull the camera back four to eight inches and give it a quick push-through. Sometimes the quick pushing motion will push the camera and termination through a tight area. Never pull the camera head back and repeatedly ram it into the pipe to get through.

Run water in the pipe while inspecting. Inspect downstream with water running to lessen the pipe's friction and wash away dirt that may collect on the camera lens.

When having difficulties pushing, it may be better to do the recording on the way back so that the video recording does not waste time showing navigation through difficult areas. Record during the pullback and use even slow strokes to pull back the pushrod.

When accessing a "Tee" entry, use a string to lift the camera head and point it in the desired direction in the Tee. Be extra careful in Tee entries not to fold the camera back on itself; this could cause the camera to get stuck in the pipe.

Be sure to use the correct model camera in the correct size pipe. Using a camera that is too big may cause it to get stuck; using a camera that is too small will result in poor lighting and video quality.

8. Camera Heads and Terminations

8.1 Parts of the Camera Heads

D34 and D46 Series Cameras for Type-CP Standard Reel

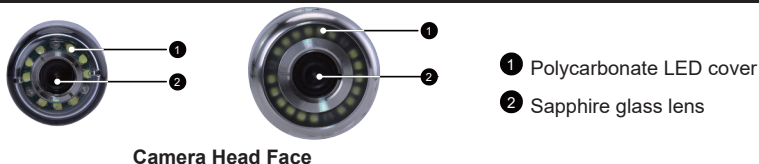

Camera Head Face

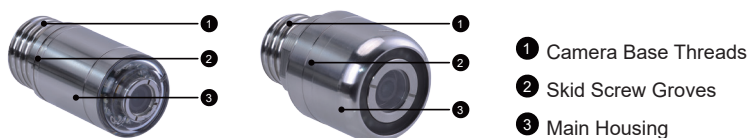

Camera Head Body

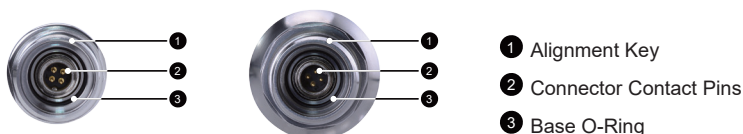

Camera Head Rear

D18-HD and D26-HD Cameras for MX Mini Reel

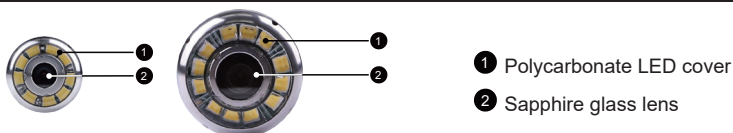

Camera Head Face

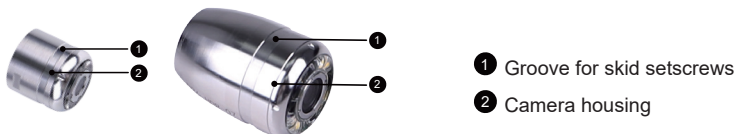

Camera Head Body

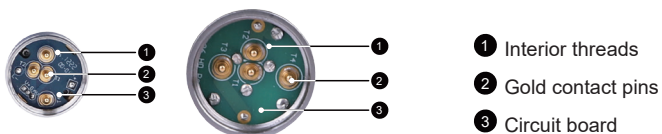

Camera Head Rear

8.1.1 Camera Head Options



The vCam series camera heads are available in various sizes for various applications. Choosing the proper camera depends on the pipe diameter to be inspected. The vCam-6 Control Module will sense the video format (PAL or NTSC) and automatically reset itself to work in that format.

The vCam-6 is an HD format control module and will record in full 1080p high definition when used with the HD version D34-HD and D46-HD camera heads. The vCam-6 will also work with older analog D34-M, D34-C, or D46-CP camera heads.



The vCamMX series cameras can be used on the MX reel with the vCam-6 control module.

All camera heads ship with a protective “standard skid” installed.

Camera Head Options for Standard Type-CP Reel

Camera Heads	Fits Reels	Description	Pipe Size Range
 <p>D34-HD and D34-C, Self-Leveling 34mm / 1.3" diameter</p>	Type-CP Standard Reel	D34-C NTSC (USA) D34-HD NTSC (USA) D34-C PAL (Europe) D34-HD PAL (Europe)	3 to 6 inches 75 to 152mm
 <p>D46-HD and D46-CP Self-Leveling 46mm / 1.8" diameter</p>	Type-CP	D34-CP NTSC (USA) D46-HD NTSC (USA) D46-CP PAL (Europe) D46-HD PAL (Europe)	3 to 8 inches 75 to 203mm
<p>Contact a local Vivax-Metrotech distributor or local office for ordering information, applications, compatibility, and pricing.</p>			

Camera Head Options for Mini MX Reel

Camera Heads	Fits Reels	Description	Pipe Size Range
 <p>D18-HD Non-Leveling 18mm / 0.76" diameter</p>	MX Mini Reel vCamDrain	18mm / 0.76" diameter	2 to 3 inches 50 to 75mm
 <p>D26-HD, Self-Leveling 26mm / 1" diameter</p>	MX Mini Reel	26mm / 1" diameter	2 to 4 inches 50 to 100mm
<p>Contact a local Vivax-Metrotech distributor or local office for ordering information, applications, compatibility, and pricing.</p>			

8.2 Spring Assembly Parts

The Spring Assembly is comprised of the parts that connect the camera head on one end and are connected to the pushrod on the other.

The spring assembly for the Type-CP Reel will consist of a spring, coiled cable assembly, and a pair of lanyards as separate parts. The termination spring assembly for the MX reel is an all-in-one assembly consisting of a spring, coiled cable, and lanyard preassembled.

8.2.1 Type-CP Spring Kits

The Type-CP reel spring is available in two lengths and configurations, allowing customization and use in various applications and conditions. For example, a short-length spring would be ideal in a larger diameter pipe due to having less side-to-side camera movement, whereas a longer spring would better suit a pipe with multiple bends and elbows.

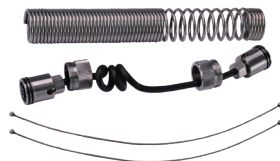

8.2.2 Spring

A hardened steel spring provides a flexible transition between the pushrod and the camera head. The flexible spring also protects the coiled cable and lanyard inside it. The spring has a long length of tight coils in the rear (end closest to the pushrod), open coils towards the front, and a short length of closed coils at the camera end. The Type-CP springs at each end of the spring end at the "lead spring coil," which is used with the camera removal tool to remove the camera from the spring and the spring from the base.



Type-CP Standard Termination Spring

- 1 Pushrod End
- 2 Open Coils
- 3 Camera End
- 4 Lead Spring Coil

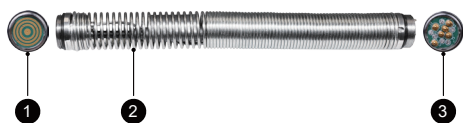

MX Mini Termination Spring Assembly

- 1 Camera End with Circular Circuit Board
- 2 Spring Assembly with Coiled Cable and Lanyard
- 3 Pushrod End with Push Pins

8.2.3 Coiled Cable Assembly

The coiled cable assembly is the electrical connection between the pushrod and the camera head. The cable is coiled to stretch without breaking as the spring moves through turns. The camera lights and video signal power run through this cable from the pushrod sonde compartment.

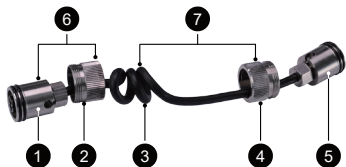

Termination Coiled Cable Assembly for Type-CP Reel

- 1 Connector Base
- 2 Floating Camera Nut
- 3 Main Cable
- 4 Floating Camera Nut
- 5 Connector Base
- 6 Rear (short pushrod end)
- 7 Front (long camera end)



Connector Base Detail

- 1 Lanyard Slots
- 2 O-Rings
- 3 Keyed 4-Pin Camera Socket

8.2.4 Lanyard Set



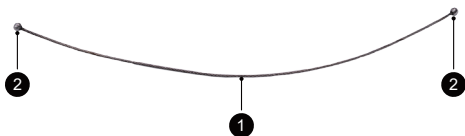

The stainless-steel set of lanyards within the spring attaches the base of the termination by the pushrod to the camera head. These lanyards prevent the spring from over-extending when retrieving the camera.





Steel Lanyard

- 1 Wire Rope
- 2 Retaining Ball

8.2.5 Termination Parts List

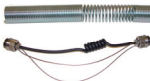
Picture	Description	Comments
	Camera Removal Tool for D34 and D46 cameras	It comes with the control module
	Coiled Cord O-Ring, 17mm x 1.5mm	Two are required at each end of the coiled cord assembly.
	Camera Body O-Ring, 15mm x 1.5mm	Located in the base of the camera below the 4-pin connector
	Coiled cable assembly, 12mm Standard	Fits D34 and D46 series cameras

	Coiled cable assembly, 12mm Short	Fits D34 and D46 series cameras
	Spring Kit, 12mm Standard (33mm dia. x 11-3/4" / 30cm long spring)	Kit includes a Spring, Coiled Cord Assembly and a pair of Steel Lanyards
	Spring Kit, 12mm Short (33mm dia. x 7" / 18cm long spring)	Kit includes a Spring, Coiled Cord Assembly and a pair of Steel Lanyards
	MX Spring Assembly	An all-in-one assembly consisting of spring, coiled cable and lanyard preassembled
Contact a local Vivax-Metrotech distributor or local office for ordering information, applications, compatibility, and pricing.		



It is a good practice always to keep a spare set of lanyards, a coiled cable and spring as a spare part. These parts are field serviceable and can be changed at a job site in minutes.

8.3 Removing the Camera Head – D34 and D46 Series Cameras

Tools needed: A Camera Removal Tool (supplied with a control module) and an optional clamping or holding device, like a vise, would be helpful. Use only the tool provided to remove the camera head.

Also, see our YouTube video



1. Clamp the pushrod into a vice at the base of the termination.
2. Position the “hook” part of the camera removal tool on top of the spring's starting coil.
3. Hold the camera in one hand while turning the spring starting coil clockwise while using the camera removal tool. Continue this until the camera is loose enough to be removed by hand.
4. After the camera head is completely off of the spring, unscrew the floating camera nut from the base of the camera by turning it counterclockwise.
5. Firmly grasp the connector base and carefully pull it out of the camera base.

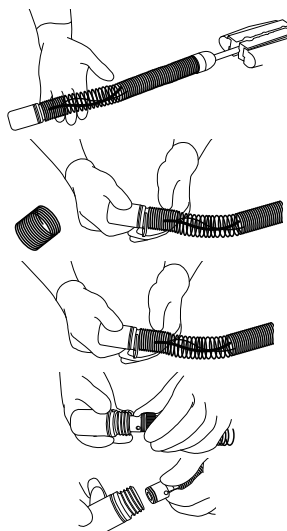

- Clean off grease and debris from the ring at the camera's base and connection plug if needed. Store the camera head in a clean, dry place to prevent corrosion to any camera parts and prevent the pins from being damaged. If storing for long periods, remove the skid from the camera head.



8.4 Removing the Standard Reel's Termination Spring and Coiled Cable

Tools needed: A Camera Removal Tool (supplied with a control module) and an optional clamping or holding device, like a vise, would be helpful. Use only the tool provided to remove the camera head.

- Follow the instructions in section 8.3, Removing the Camera Head to remove the camera.
- Position the "hook" part of the camera removal tool on top of the spring's starting coil.

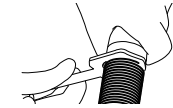

- Turn the spring counterclockwise using the tool until it is loose enough to be removed by hand. Completely remove the spring.

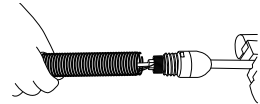

- Unscrew the floating camera nut from the termination base.



- Firmly grasp the connector base and pull it out of the termination base.

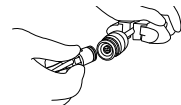

- Clean off grease and debris from the ring at the camera's base and connection plug if needed. Store the camera head in a clean, dry place to prevent corrosion to any camera parts and prevent the pins from being damaged. If storing for prolonged periods, remove any skids from the camera head.



8.5 Installing the Standard Reel's Coiled Cable and Termination Spring

8.5.1 Pre-check the Termination Parts

Do a pre-check of the termination parts before installing them. Replace any parts if you have any doubts about them. Put all the parts outside the spring and use a control module attached to the reel to look for video and LED lighting control. All the connectors, O-rings, and threads must be clean and free of debris between the threads.

8.5.2 Pre-checking Steel Lanyards

These lanyards prevent the spring from over-extending when retrieving the camera.

Check the lanyards for:

- Steel Balls** – Check that the balls on the ends are secure, not deformed, and show no signs of rust.
- Wire rope** – Check for splinters, abrasions, kinks, and signs of rust.



8.5.3 Pre-checking the Coiled Cable Assembly

The coiled cable assembly is the electrical connection between the pushrod and the camera head. This is better checked while attached to the termination base and camera head.

Check the Coiled Cable for:

- **Jacketing** – Check that the jacket of the cable does not have any cuts or abrasions. When connected to a control module, wiggle the cable at the base of the connections to check for hidden breaks in the cable.
- **Connectors** – Check that the plastic 4-pin connectors at each end are clean and in good condition.
- **O-rings** – Check the O-rings for wear, cuts, and other damage.
- **Continuity** – Attach the coiled cable to the termination base and a camera head. Attach the reel to a control module and power it on. Check for video signal, LED lighting, and lighting control.
- **Floating camera nuts** – Check that the threads on the floating camera nut are not damaged, are clean of dirt, and the round shape is not deformed.

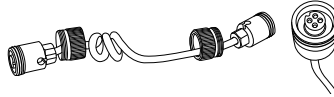
**8.5.4 Pre-checking the Spring**

The termination spring provides a flexible transition between the pushrod and the camera head.

Check the termination spring for:

- **Deformity** – Check that the spring is not deformed
- **Lead coil** – Check that the lead coil is not bent, broken, or protruding
- **Rust** – Check that rust has not compromised the spring material

8.6 Installing the D34 and D46 series Camera Heads onto the Type-CP Standard Reel

Also, see our YouTube video

**8.6.1 Install the Coiled Cable and Termination Spring**

The lengths of the cable after the coiled part are different. One is longer than the other. The longer end gets attached to the camera, while the shorter end gets attached to the termination base.

The 4-pin male plug and female socket mount the camera head “keyed” connectors. The keyed notch on the camera base must line up with the keyed groove in the coiled cable socket. Failure to align these keys correctly will damage the camera pins and coiled cable connector or the termination base connector.



When assembling the camera or coiled cable, the control module should be powered off or interconnect the lead un-plugged. Failure to do so may result in shorting out the camera head.

1. Clamp the pushrod into a vice at the base of the termination.
2. Clean the threads in the termination base, then apply a liberal bead of silicone grease to the female base threads.

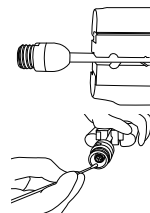

3. Feed the two lanyards through the floating camera nut and insert it into the lanyard slots. Ensure the lanyards are straight and not tangled in the coiled cable.

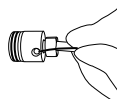

4. Pull the floating camera nut up and over the lanyards.

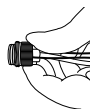

The 4-pin male plug and female socket used to mount the camera head are “keyed” connectors. The keyed notch on the camera base must line up with the keyed groove in the coiled cable socket. Failure to align these keyways correctly will damage the camera pins, coiled cable connector, or termination base connector.

5. Line up the 4-pin female connector notch with the 4-pin male connector in the termination base.



6. Insert the coiled cable connector into the termination base. **Hand tighten only.** Do not use any tools to tighten this connection.



7. Feed the opposite end of the lanyards through the floating camera nut and insert it into the opposite connector base lanyard slots. Ensure the lanyards are straight and not tangled in the coiled cable.

8. Pull the knurled camera nut up and over the lanyards.

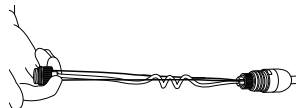

9. Wrap electrical tape around the floating camera nut, securing the nut with lanyards to the connector.

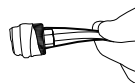

10. Slide the spring over the coiled cable assembly.

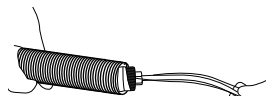

11. Screw the spring into the termination base. Tighten by hand, do not use any tools.

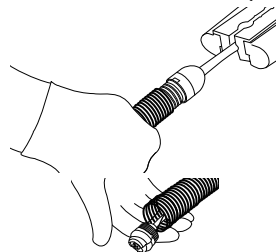

12. Pull enough of the coiled cable to attach a camera head.

8.6.2 Pre-checking the Camera Head Before Installing

If the occasion should arise where a camera head must be re-installed or replaced, pre-check these items before the camera is fully installed. The visual checks can be done in an area with good lighting using a magnifier. Some checks are better done with the camera LEDs turned on. For these checks, you can use the camera test port, a camera test lead, or the coiled cable plugged into the termination base of a reel connected to a powered-on control module.

8.6.3 Pre-checking for Picture and LED Control

Visually check the 4-pin female connector on the camera and the 4-pin male connector on the coiled cable. Line up the keyed connector on the coiled cable to the camera head and attach them. Attach a reel to a control module and power it on. Through the control module, check for an acceptable picture, the LED lights on, the camera work, and you can control the LED lights. While still connected to the control module with a picture showing, wiggle the cable at the base of the connections to check for hidden breaks in the cable.

8.6.4 Pre-checking the Camera Base O-Ring

Visually check the O-ring for wear, cuts, and deformation. Replace the O-ring if you have any doubts. Apply a bead of silicon-based grease to the O-ring and the camera head's female base threads before installing the camera head.

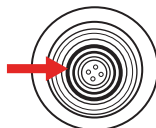

8.6.5 Pre-checking the Camera Glass Lens and LED Cover

This pre-check is better done with a control module attached to a reel or by the camera test port. For this pre-check, the LED lights should be on so that the camera face can be better examined.

Pre-checking the LED Cover

The Polycarbonate LED cover is the section of the face of the camera that covers the LEDs.

Visually check the inside and outside radius for chips and cracks.

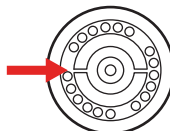

Sapphire Glass Lens

The Sapphire Glass camera lens is the center clear glass section of the camera face. Visually check the outside radius for chips and cracks. Visually check the surface of the glass for scratches.

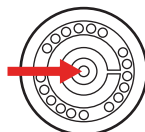

If you suspect that any cracks or chips may let moisture in or that scratches on the lens may affect the video quality, contact the factory or your local dealer.

8.6.6 Installing the D34 and D46 Series Camera Heads

After pre-checking the termination parts and camera head, the camera head is now ready to be installed.

The only materials needed are a 1cc tube of silicon-based grease and a swab applicator. No tools should be used to install the camera head or termination parts. These require only hand tightening.

Use a dry rag to grip the floating camera nut better if there is a grease residue around the area.



The 4-pin male plug and female socket mount the camera head “keyed” connectors. The keyed notch on the camera base must line up with the keyed groove in the coiled cable socket. Failure to align these keyways correctly will damage the camera pins and coiled cable or termination base connector.



When assembling the camera or coiled cable, the control module should be powered off or interconnect lead unplugged. Failure to do so may result in shorting out the camera head.

1. Use a swab applicator to apply a silicone grease bead onto the camera base's female threads. Use a fingertip and apply a bead of silicone grease on top of the 2 O-rings on the coiled cable connector.

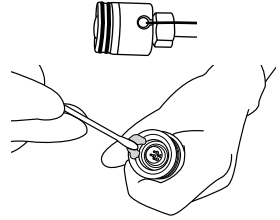

2. Feed the coiled cable with lanyards through the spring. Feed an amount that is comfortable to work with.

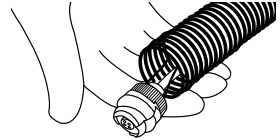

Use a nylon cable tie to compress some of the coils in the spring. This will give you a few inches of space to work in while attaching the camera.

3. Line up the keyway on the 4-pin male and female socket and plug and press the coiled cable connector into the camera head.

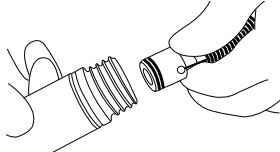

4. Pull up the floating camera nut to cover the lanyard mounting holes and screw the nut into the camera head. **Do not use any tools; only tighten by hand.**

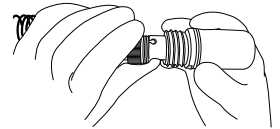

5. To prevent the lanyards from becoming twisted during the installation of the camera head, first, turn the camera attached to the cable assembly counterclockwise seven complete turns. Now when screwing the camera head into the spring, the lanyards should not be twisted and wrapped around the coiled cable.

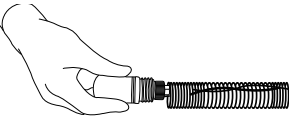

Screw the camera head clockwise into the termination spring until it is flush with the spring. Hand tighten only.

8.7 Removing and installing the Type-MX Reels D18-HD and D26-HD Camera Heads

Do not touch the green circuit board or gold pins on the spring assembly or camera head with bare hands. Touching these will transfer oils from the fingers to these components, leading to premature corrosion. Wear clean rubber gloves if possible.

The Type-MX reel is supplied with tools for camera and spring removal and installation.

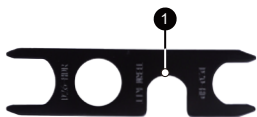

- ① Wrench flats for camera and spring removal/installation

Camera head removal

1. Use the section of the tool labelled TERM KIT to hold the flats on the spring.
2. Place the section of the other tool labelled D26-HD or D20-HD on the camera head flats and turn counterclockwise until the camera is loosened.
3. Proceed to unscrew the camera head by hand until it is removed.

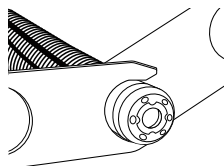
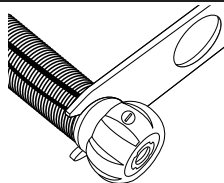

Camera head installation

Remove any excess dirt that might contact the gold pins or green circuit board. Check that the O-ring is in good condition. Wipe the circuit board in the spring and camera contact pins with an alcohol wipe or swab.

1. Use the section of the tool labelled TERM KIT to hold the flats on the spring.
2. Screw on the camera head by hand until the O-ring is engaged.
3. Use the section of the tool labelled D20-HD or D26-HD of the other tool on the camera head flats and turn clockwise **until the O-ring is no longer visible**.

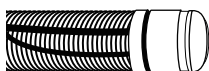
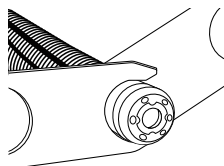
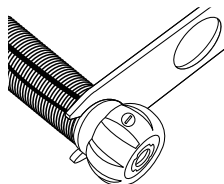

Visible O-Ring



O-Ring is no longer visible

8.8 Removing and Installing the Spring Assembly

Don't touch the green circuit board, gold pins on the spring sonde assembly, or camera head with bare hands. Touching these will transfer oils from the fingers to these components, leading to premature corrosion. Wear clean rubber gloves if possible.

1. Remove the camera head following the instructions shown in section 8.3.

2. Firmly hold the knurled base kit with one hand.

3. Apply the section of the tool labeled TERM KIT to the flats of the Spring Assembly.
4. Turn the tool counterclockwise to loosen and remove the spring assembly.

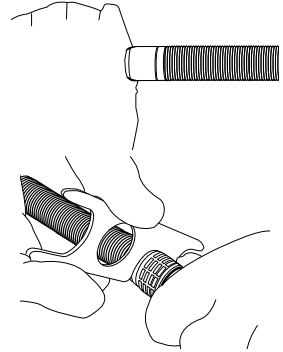

Installing: Remove any excess dirt that might get onto the gold pins or green circuit board. Check that the O-rings are in good condition.

1. Firmly hold the knurled base kit with one hand.
2. Screw on the spring buy hand until the O-ring is engaged.

3. Use the tool section labelled TERM KIT and continue to screw on the spring while holding the knurled base kit.

4. Tighten with the tools until the O-Ring is no longer visible.

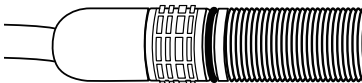
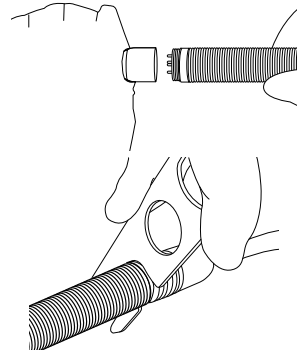

Visible O-Ring

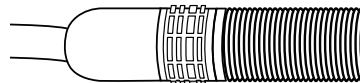

O-Ring is no longer visible

9. Camera Skids

9.1 Camera Skids

Camera skids are devices that attach to the camera head to 1) keep the camera head off the floor of the pipe to help avoid pushing up debris and dirt, which will end up on the camera lens, blocking your view, 2) allow the camera LED lighting to function better by keeping the lights more centered in the pipe allowing a more even spread of light on the pipe walls and ahead and 3) provide protection to the camera head by giving a shoveling effect which allows the camera head to be lifted over offsets and objects which helps prevent the camera head from making direct contact with them. Lastly, the skids will help increase the pushing distance of the camera and pushrod by providing a more non-binding material to slide against plastic, clay, metal, and cement pipes. There are a variety of skids for specific uses and camera sizes and a few different methods of attaching the skids to the camera system.

9.1.1 Camera and Spring Skids, Installing and Removing

The vCamDrain system uses various types of skids.



Standard Skids



Guide Skid



Clip together Skid



Spring Skid

9.1.2 Standard Skids, screw in setscrews, D18 series, D26-MX, D34 and D46 series

The standard skids ship installed on the camera head.

Tools Needed: 3mm / 1/8-inch flat screwdriver.

1. Use the screwdriver to back out the three set screws so the camera head will slide unobstructed into the standard skid.
2. Slide the camera head into the standard skid until the head is flush with the front.
3. Use the screwdriver to secure the standard skid to the camera head.

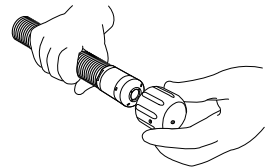
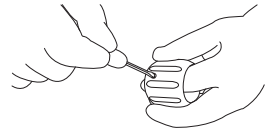

Do not overtighten the set screws. This may result in stripping the set screw, the skid threads or damage to the camera housing.



Apply a layer of electrical tape over the screw holes on the installed skid. This will help keep debris from filling the screw slot, making removing them easier.

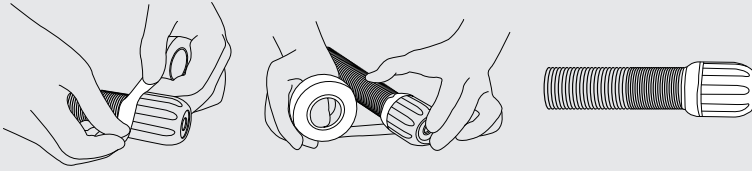

9.1.3 Standard Skids, Two-part clip together, D26-HD

Tools Needed: No tools are needed.

1. Press in on the locking tabs while pulling the two parts apart.



2. Remove the camera from the spring and slide the rear of the skid onto the spring with the tabs facing forward.

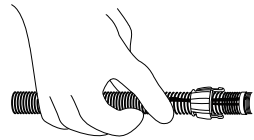
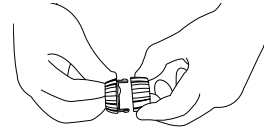

3. Install the camera head onto the spring. Ensure that the camera head is installed correctly by using the camera tools and tightening it until the O-ring is no longer visible.



4. Slide the front of the skid over the camera head, aligning the locking tabs with the receptacles.

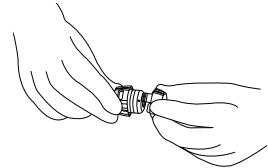

5. Press the two skid halves together until the tabs lock into the receptacles.

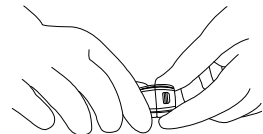

9.1.4 Spring Skids, Clamp around camera spring D18-HD on the vCamDrain Spring

Tools Needed: No tools are needed.

1. Press the locking tab to open the spring skid.

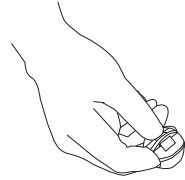

2. Present the open skid to the spring.

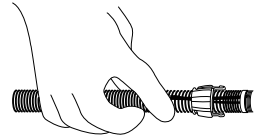
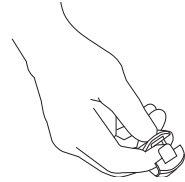

3. Close the skid and press until the locking tab clicks and locks into the mating part.

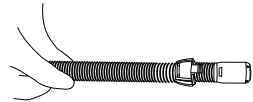

9.1.5 Guide Skids, Clamp around the camera head D18 series, D26 series, D34 series and D46 series

Tools Needed: 5mm Hex wrench.

1. Use a hex key and loosen the screws so the skid will slide unobstructed onto the camera head.

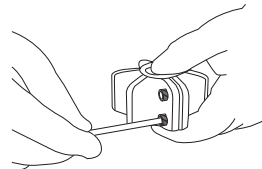

2. Slide the camera head into the skid until the head is flush with the front.

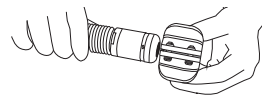

3. Use a hex key to secure the skid to the camera head.

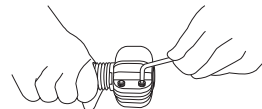

4. Check that the skid is secure by turning and pulling it simultaneously.

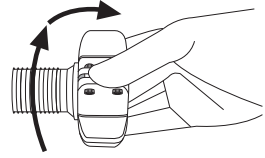

Refrain from attempting to close the guide skid fins together completely. Doing so can result in damage to the camera head or the skid.

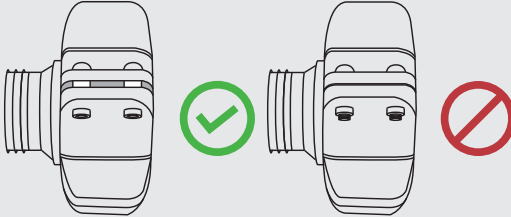

10. Locating Sondes and Pushrod

10.1 Introduction

The Type-CP and Type-MX reels include a locatable sonde at the base of the spring termination assembly. The controls for the sonde are located on the front panel of the control module.

The newer version of the Type-CP reel (purchased after April 2014) and all MX reels can trace the entire pushrod length. A utility locator's transmitter is used externally to send a locate signal through the length of the pushrod.

Vivax-Metrotech manufactures a range of utility locators and sonde locators. Information and instructions on these locators can be found on our website or by contacting your local distributor for more information.

10.2 Applying a Locate Signal onto the Pushrod

A utility locator transmitter is required to locate the pushrod. Frequencies starting at 33kHz and above will work better than lower frequencies.

1. Lock the cable cage by using the brake lock.
2. Connect the red-colored hot lead from the transmitter to the contact post on the Type-CP or MX reel. Refer to the diagrams in sections 2.5.2 and 2.5.3 for the contact post location for the reels.

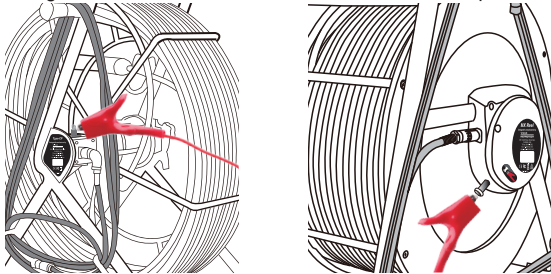

3. Place the utility locator transmitter:
 - a) Place the transmitter out of the reel's general work area.
 - b) Place the transmitter to prevent the leads from becoming tangled in the spinning reel cage.
 - c) Place the transmitter so that the leads are not crossing over the path of the pushrod in the pipe.
4. Insert the transmitter's ground stake in earth approximately five feet at a right angle to the reel.

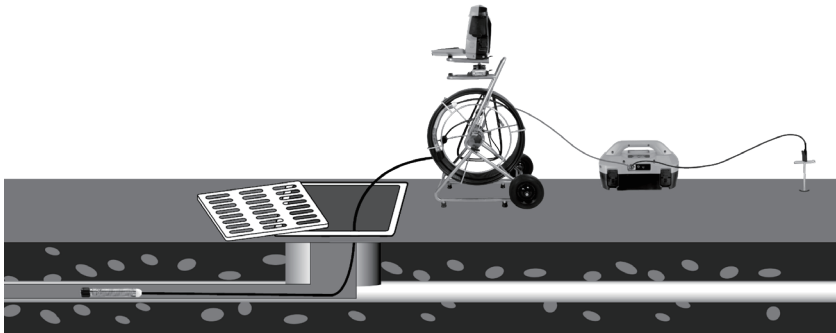

5. Turn on the utility locator transmitter and select a frequency. We recommend using a higher frequency, such as 33 kHz, 65 kHz, or 83 kHz. Ensure that the transmitter has good ground. The better the ground, the better the locator will perform.
6. Use the utility locator in the line mode, not sonde mode, to trace the path of the pushrod underground.



**Always “Call Before You Dig” and follow your company’s safety practices.
Always follow local, state, and national regulations.**

Sonde Locating

The best practice for locating the camera sonde is to push the camera into the pipe, and when it is level, stop and do the locate. From this point on work in 10 to 20-foot increments stopping every 10 to 20 feet and locate the sonde. It is not good practice to push the camera into the pipe a great distance away and set out to locate it. The distance counter in the control module may estimate how far the camera has been deployed, but this is just for reference.

10.3 Sonde and Camera Locating

When this manual is published, the vLoc3-Cam and VM-540 sonde locators are available. Information and instructions for these locators are available on our website at www.vivax-metrotech.com.



**Always “Call Before You Dig” and follow your company’s safety practices.
Always follow local, state, and national regulations.**

11. Troubleshooting

Please check the Knowledge Center on the Vivax-Metrotech website for the latest support information.

Go to www.vivax-metrotech.com and then click **Support, Knowledge Center**.

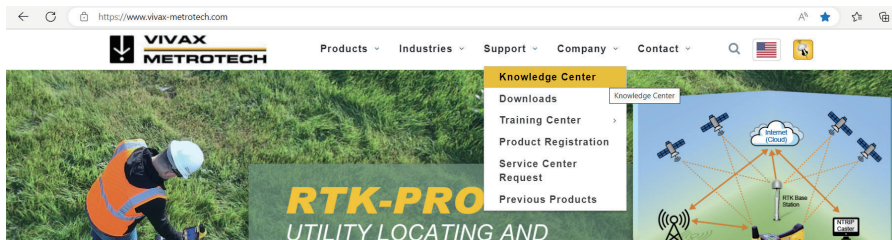

PROBLEM: No power. The unit will not turn on:

Check:

1. Check to see if the fuse is installed, blown, or damaged in any way. The unit will not charge your battery if the fuse is not installed.
2. Try using mains current and not battery to turn on the unit. If the unit does power on with mains current, then your battery is not charged, which may be why it will not power on.
3. While the unit is charging, see if the battery icon on the front panel is glowing red, or if turned on, you see a lightning bolt inside the battery icon on the bottom right corner of the LCD.

Note:

On serial numbers below 1090 1100 00001, the charging indicator will glow red while charging and go blank when fully charged.

On serial numbers above 1090 1100 00001, the charging indicator will glow red while charging and turn green when fully charged.

PROBLEM: No picture and no grey status bar:

Check:

1. Check that both ends of the interconnect cable are plugged in.
2. If the camera has lighting, remove it and plug it into the test port.
3. Check both ends of the coiled cable in the spring. Move the cable at the ends to see if the video loss is intermittent with the camera connected and powered on.

PROBLEM: Black screen, no picture with grey status bar:

Check:

1. Perform a visual check looking for possible point's water entry. Check the camera head for cracks in the glass lens or plastic LED cover.
2. Plug the camera head into the test port, looking for video and lighting.
3. Inspect the coiled cable for cuts or chafing. Flex both ends of the coiled cable, looking for an intermittent connection under the cable jacket.
4. Inspect the interconnect cable, looking for cuts or chafing. Flex both ends of the cable, looking for an intermittent connection under the cable jacket.

PROBLEM: Not recording:**Check:**

1. Check the battery level. The unit may not have enough power to record when the battery is low.
2. Check available disk space on the HDD, USB, or SD card.
3. Check your default storage setting.

PROBLEM: Sonde is not working:**Check:**

1. Check the battery level. When the battery is low, the sonde may not operate.
2. Check that the sonde frequency in the control module matches that of the sonde locator.

PROBLEM: Distance counters not accurate:**Check:**

In the menu settings for reels, check:

1. Check if the distance counter setting is set to Meters or Feet.
2. Check the type of reel used setting is correct.
3. Check that the friction brake is not slowing the cage so much that it jerks in and out.

PROBLEM: Distance counter not counting:**Check:**

Check the condition of the Interconnect Cable between the control module and the reel. With the unit powered on and the interconnect cable attached between the control module and reel, twist the interconnect cable wire close to the connectors while watching the distance counter on the display. Try and switch the interconnect cable with another working unit.

PROBLEM: Interference or noise on LCD:**Check:**

In some circumstances, the Sonde can cause interference in the video being viewed or recorded. The Sonde is recommended to be turned off unless it is being used for location. This also saves power.

PROBLEM: The control Module keeps rebooting with a "Control Module settings have changed" message:**Check:**

Check for loose connections to or damage to the termination coiled cable, interconnect cable, or damage to the reel.

PROBLEM: SD or USB device not recognized:**Check:**

1. Make sure the media device is working and not corrupt.
2. Try formatting the device in the control module.
3. Read the section in this manual, "File Format of SD Cards and USB Drives."

PROBLEM: No audio being heard on recorded video:**Check:**

1. Check that the volume is turned up during playback. Use the key function Ctrl – to lower the volume and Ctrl + to raise the volume.
2. Ensure that the red microphone icon is on the status bar and that the microphone button is illuminated during the audio recording.
3. Assure that the audio comments were directed towards the internal microphone between one and three feet from the internal microphone.
4. Try using an external microphone.

PROBLEM: Dark or hard-to-view display:**Check:**

1. Press the "F9 Display" key and check the display settings.
2. Turn the camera LED lights up.

PROBLEM: Error messages for USB and SD cards, not enough free space or not found.**Check:**

1. Check that the USB device is a minimum of 8GB and not bigger than 128GB.
2. Check that the USB device was formatted in FAT32 or NTSC file format.

PROBLEM: Blurry picture**Check:**

1. Remove the camera head and plug it into the camera test port.
2. Water may have intruded into the camera head if the picture remains blurry.
3. Return the camera head for inspection.
4. If the picture is clear when the camera is in the test port, there may be a kink in the pushrod or water damage to the interconnect cable's 90-degree plug.

Illustrations used in this manual's preparation will inevitably show some resemblance to similar images from other manufacturers. These manufacturers have permitted the use of their graphics, and this statement is intended to attribute such credit.

iOS is a Cisco Systems, Inc. trademark registered in the U.S.
Android, Google and Google Maps are registered trademarks of Google LLC.
DROPBOX is a registered trademark of DROPBOX, Inc.
BOX Software is a registered trademark of BOX, Inc.
OneDrive and OneNote are registered trademarks of Microsoft.
Wi-Fi is a trademark of the Wi-Fi Alliance.

Disclaimer: Product and accessory specifications and availability information are subject to change without prior notice.



Online Manual

Vivax-Metrotech Corporation

3251 Olcott Street, Santa Clara, CA 95054, USA

Toll-Free: 1-800-446-3392

Phone: +1 (408) 734-3880

Website: www.vivax-metrotech.com